



Electricity Network Standards:

ESA002 Electricity Network Connection Standard

STANDARD

© Vector Limited 2026

The information contained in this document is proprietary to Vector. Please keep it confidential. By using this document, you agree to protect it from loss, misuse, and disclosure to any person who does not need to know the information within it to fulfil obligations owed to Vector.



Table of Contents

I.	Document Control	4
II.	Document Revisions	4
III.	Document References	4
IV.	Glossary of Terms	7
1.	Introduction	11
1.1	Purpose	11
1.1.1	<i>Intended audience</i>	11
1.1.2	<i>Scope of this Standard:</i>	11
1.2	Who can carry out electrical work on private property?	11
1.3	Health, Safety and Environment	12
1.4	Summary of roles and responsibilities	12
2.	Connecting to Vector's Electricity network	13
2.1	Summary of the application process for a new connection	13
2.2	Determining the scope of the installation	13
2.3	Guidelines for selecting Electrical Service Providers	15
2.4	Guidelines for engaging with Electricity Retailers	15
2.5	Applying for temporary builder's supply	15
3.	Information for customers with existing connections	17
3.1	What electrical equipment do I own and am responsible for?	17
3.2	Maintenance Activities	17
3.2.1	<i>Mandatory routine electrical inspections for special installations</i>	17
3.2.2	<i>Other routine maintenance activities</i>	18
3.3	Managing the risk of digging into service cables	19
3.4	Restrictions for working or building near Vector powerlines	19
3.5	Responsibilities for customers with Vector equipment on their premises	19
3.6	Vector to inform WorkSafe of electrically unsafe installations	20
3.7	Planned interruptions	20
4.	Information for customers modifying their connections	21
4.1	Requirements for customers increasing their capacity	21
4.2	Requirements for disconnecting from Vector's electricity network	21
4.3	Requirements for reconnecting to Vector's electricity network	21
5.	Technical design requirements	22
5.1	General requirements	22
5.2	Vector's system of supply	22
5.2.1	<i>Voltage</i>	22
5.2.2	<i>Earthing</i>	22
5.2.3	<i>Frequency</i>	22

5.2.4	<i>Prospective short circuit current</i>	23
5.3	Quality of supply	23
5.3.1	<i>Voltage imbalance</i>	23
5.4	Service connections.....	23
5.4.1	<i>LV Connections</i>	24
5.4.2	<i>Substation Connections</i>	24
5.4.3	<i>HV Connections</i>	25
5.4.4	<i>Overhead LV Service Lines</i>	25
5.4.5	<i>Underground LV Service Cables</i>	25
5.4.6	<i>Service pits or pillars</i>	26
5.5	Electrical Protection	26
5.5.1	<i>Protection</i>	26
5.6	Supply capacity.....	27
5.6.1	<i>Supply capacity – residential and general (<100A)</i>	27
5.6.2	<i>Supply capacity – Rural residential and general (<100A)</i>	28
5.6.3	<i>Supply capacity – Rural subdivisions</i>	28
5.6.4	<i>Supply capacity – Commercial</i>	28
5.6.5	<i>Prospective short circuit rating – Commercial</i>	29
5.6.6	<i>Parallel operation of transformers – Commercial</i>	29
5.7	Earthing.....	29
5.8	Metering	30
5.8.1	<i>LV Metering – residential and general customer (≤100A)</i>	30
5.8.2	<i>HV Metering – commercial customer (>100A)</i>	31
5.8.3	<i>Unmetered supplies</i>	31
5.9	Network Disturbance	32
5.9.1	<i>Radio interference</i>	33
5.10	Signalling.....	33
5.11	Easements	33
5.12	Generators	33
5.13	Battery storage systems	33
5.14	Electric Vehicle chargers	34
5.15	Distributed Energy Resource Management	34
6.	Network connection configurations	35
6.1	Configuration A – Underground residential and general connections	35
6.1.1	<i>General ownership diagram</i>	35
6.1.2	<i>Customer responsibilities</i>	35
6.1.3	<i>Important design requirements</i>	35
6.2	Configuration B – Overhead residential and general connections for Rural areas.....	36
6.2.1	<i>General ownership diagram</i>	36
6.2.2	<i>Customer responsibilities</i>	36
6.2.3	<i>Important design requirements</i>	37
6.3	Configuration C – Long overhead connections for rural areas	37
6.3.1	<i>General ownership diagram</i>	37
6.3.2	<i>Customer responsibilities</i>	38
6.3.3	<i>Important design requirements</i>	38

6.4	Configuration D – Multi-dwelling connections	38
6.4.1	<i>General ownership diagram</i>	38
6.4.2	<i>Customer responsibilities</i>	40
6.4.3	<i>Important design requirements</i>	40
6.5	Configuration E – Transformer connection (for connections over 100 A / 3 phase) 41	
6.5.1	<i>General ownership diagram</i>	41
6.5.2	<i>Customer responsibilities</i>	42
6.5.3	<i>Design requirements</i>	42
6.6	Configuration F – HV Customer connections	43
6.6.1	<i>General ownership diagram</i>	43
6.6.2	<i>Important considerations before committing to this installation configuration</i>	43
6.6.3	<i>Customer responsibilities</i>	44
6.6.4	<i>Important design requirements</i>	44
6.7	Configuration G – Transformer connections to commercial developments with multiple tenants.....	44
6.7.1	<i>General ownership diagram</i>	44
6.7.2	<i>Customer responsibilities</i>	45
6.7.3	<i>Important design requirements</i>	45
6.8	Customer sites supplied by multiple Points of Supply.....	46
7.	Disconnection from the Network	46
7.1	Disconnection of Customer Assets.....	46
Appendix A DRAWINGS		47
Appendix B FAULT LEVEL		48
B.1.1	11kV network	48
B.1.2	22kV network	48

I. Document Control

Document Author	Jane Liu	Principal Network Planning Engineer
Document Owner	Steve Heinen	General Manager – Network Performance
Reviewed By	Jacques de la Bat	Future Network and Planning Manager
	Nadia Botha	Manager Customer Contracts
Date for next review	June 2026	

II. Document Revisions

Approved Versions	Date	Revision Notes
1.0	May 2019	Network Connection Standards developed
2.0	December 2022	Integration of smart hot water load control, electric vehicle charging, distributed energy resource management system and revised to reflect latest pricing and easement policies.
3.0	April 2023	Updated diagrams and wording within Section 5.8.1 relating to metering enclosure dimensions.
4.0	May 2023	Updated wording within section 5.14.
5.0	April 2026	Added Section 7 Disconnection of Customer Assets

III. Document References

Document Number	Description	Location
	Main page: Vector.co.nz	Vector's website
	Application for a new connection to the network: vector.co.nz/personal/get-connected	Vector's website
	Application for connection of generators to the network: vector.co.nz/personal/electricity/distributed-generation	Vector's website
	Application for connection of batteries to the network: vector.co.nz/personal/batteries/connecting-your-battery-to-our-network	Vector's website
	Application for disconnecting a connection: vector.co.nz/decommissionicp	Vector's website
	Vector's electricity pricing schedule: vector.co.nz/personal/electricity/about-our-network/pricing	Vector's website
	Customers ownership responsibility:	Vector's website

vector.co.nz/personal/electricity/what-you-need-to-know/line-ownership		
Service standards: vector.co.nz/blob/vector/media/vector2021/vector_service_standard_res_2021-04.pdf		Vector's website
Safety guidelines: vector.co.nz/personal/help-safety		Vector's website
EGA003	Approved Inspectors working on or near Vectors assets guideline	Internal Document
EGP503	Smart Metering Guideline	Internal Document
END-2020	Service Pillar Arrangement (one 3 phase mains)	Internal Document
END-2021	Service Pillar Arrangement (up to 3 single phase mains)	Internal Document
END-2024	Service Pillar Arrangement (1 x 3 phase plus 1 x 1 phase or 4 x 1 phase mains)	Internal Document
END-2120	Single-Sided Underground Reticulation	Internal Document
END-2121	Double-Sided Underground Reticulation	Internal Document
END-2122	Service Pit Arrangement Typical Cross-Section and Installation Details	Internal Document
END-2123	Service Pit Arrangement up to Three Single Phase Customer Connection Plus Earth	Internal Document
END-2124	Service Pit Arrangement Three Phase Customer Connection Plus Earth	Internal Document
END-2126	Service Pit Arrangement Details of Neutral Screen Cable Breakout	Internal Document
END-2127	Service Pit Arrangement Three Phase plus Single Phase Customer Connections Plus Earth	Internal Document
EOS-009	Commissioning of network equipment	Internal Document
ESE501	Distribution Substations in Buildings	Internal Document
ESE502	Outdoor Ground Mounted Distribution Equipment	Internal Document
UPA006	Electricity and Gas Easements Policy	Internal Document
Electricity Act	Electricity Act 1992	External Document
ECP 34	New Zealand Electrical Code of Practice for Electrical Safe Distances	External Document
ECP 35	New Zealand Electrical Code of Practice for Power Systems Earthing	External Document
ECP 36	New Zealand Electrical Code of Practice for Harmonic Levels	External Document

ECP 46	New Zealand Electrical Code of Practice for High Voltage Live Line Work	External Document
ECP 50	New Zealand Electrical Code of Practice for Repair and Maintenance of Domestic Electrical Appliances by the Owner of the Appliance	External Document
ECP 51	New Zealand Electrical Code of Practice for Homeowner/Occupier's Electrical Wiring Work in Domestic Installations	External Document
ECP 54	New Zealand Electrical Code of Practice for the Installation of Recessed Luminaires and Auxiliary Equipment	External Document
ECP 55	New Zealand Electrical Code of Practice for Managing Electrical Risks Associated with Electrically Conductive Thermal Insulation	External Document
ECP 60	New Zealand Electrical Code of Practice for Inspection, Testing and Certification of Low Voltage A.C. Railway Signalling Control Circuits	External Document
AS/NZS 3000	Wiring rules	External Document
AS/NZS 3019	Electrical Installations – periodic verification	External Document
AS/NZS 3760	In-service safety inspection and testing of electrical equipment	External Document
AS/NZS 4777.1:2016	Grid connection of energy systems via inverters - Part 1: Installation requirements	External Document
AS/NZS 4777.2:2020	Grid connection of energy systems via inverters, Part 2: Inverter requirements	External Document
AS/NZS 61000	Part 3 - Electromagnetic capability (EMC)	External Document
IEC 61000	Part 3 - Electromagnetic capability (EMC) - limits	External Document
SNZ PAS 6010:2021	Electric vehicle (EV) chargers for commercial applications	External Document
SNZ PAS 6011:2021	Electric vehicle (EV) chargers for residential use	External Document
	EEA guide for livening of service connections to premises	External Document
	Electrical Workers Registration Board - Electrical standards ewrb.govt.nz/for-registered-electrical-workers/your-licence/access-nz-standards-for-all-electrical-installations-and-appliances/	External Document
	Electrical Workers Registration Board - work competencies ewrb.govt.nz/working-safely-and-in-compliance/limits-of-work/	External Document
	Electricity (safety) regulations	External Document

	Good practice guidelines – Excavation safety worksafe.govt.nz/dmsdocument/17-excavation-safety	External Document
	Radio communications (EMC standards) Notice 2015	External Document
	Radiocommunication regulations	External Document
	Requirements for LV Installations worksafe.govt.nz/topic-and-industry/electricity/installations-and-networks	External Document
	The NZ Electrical Supply Authority Engineers Institute Committee Report on Motor Starting Currents for A.C. motors published in February 1982.	External Document

iv. Glossary of Terms

Term	Description
AC	Abbreviation for ‘alternating current’.
Amps (A)	Abbreviation for ‘ampere’, a base unit of electrical current.
Certificate of Compliance or CoC (Electrical)	A certificate issued by a licensed electrical worker to certify that installation or Part installation under Part 1 or Part 2 of AS/NZS 3000 are safe to be connected to the specified system of electrical supply.
Conductor	Material that allows the flow of electrical current in one or more directions.
Customer	Any person who is supplied, or who applies to be supplied with electricity from Vector’s electricity network via a Point of Supply (POS). Each customer site has a unique ICP number.
DC	Abbreviation for ‘direct current’.
Distributor Agreement	Distributor Agreement means either Vector’s Default Distributor Agreement or any alternative Agreement setting out the terms and conditions on which Vector provides Distribution Services to the Trader (Retailer).
Earthed	Electrically connected to a general mass of earth and is regarded to be at zero potential.
Electric shock	Occurs upon contact of a (human or animal) body part with any live conductor that causes a magnitude of current to pass through the body.
Electrical appliance	Any device that consumes electrical power when connected to the customer’s AC electrical supply.
Electrical safety Certificate (ESC)	Provides a legally recognisable statement that the connected installation or part installation, or any fitting that supplies an installation or a part of an installation, is safe to use following prescribed electrical

	work. Note that this can be incorporated into the Certification of Compliance.
Electrical Service Provider	A person who is professionally qualified with qualifications recognised by the Electrical Workers Registration Board (ewrb.govt.nz) to carry out work on electrical installations. Depending on the type of work this may be a registered electrician, electrical installer, electrical maintainer, cable jointer or line mechanic.
Electricity Retailer	Electricity Retailer means an entity that supplies electricity to another person or other persons for any purpose other than for resupply by the other person or persons.
Energy/Power	Energy is the ability to do work, measured in electricity distribution terminology as kilowatt-hours (kWh). Power is the measure of rate of use of energy and is defined in electricity distribution terminology as kilowatts (kW).
Fuse	Devices that protect electrical circuits by opening the circuit if the power exceeds its rated limit. Once a fuse is blown it needs to be replaced.
Generator	Equipment that is capable of producing and exporting electricity into the electricity network.
High Voltage (HV)	Any voltage exceeding 1000 Volts AC or 1500 Volts DC.
HV Engineering Consultant	A specialist consultant who advises customers on the design of HV installations.
Installation	All fittings beyond the Point of Supply (POS) that form part of a system that is used to convey electricity to a point of consumption, or used to generate or store electricity (as defined in the Electricity Act 1992 as “Electrical Installation”). Installations do not include household appliances that consume electricity.
Installation Control Point (ICP)	An Installation Control Point (ICP) is a unique identifier for each installation where a connection is made to the electricity network. Generally, there is one ICP for each installation, although some installations may have multiple ICPs due to multiple connections to the electricity network. The ICP is specific to the site location and not attached to the customer.
Isolate	The process of disconnecting the source of electricity supply from the installation. This is generally carried out by opening a switch or circuit-breaker, removing an isolating link or fuse or disconnecting a cable or line.
kV	Abbreviation for ‘kilovolts or 1000 Volts.
Live	Means charged with electricity so that a difference in voltage exists to earth or between conductors.
Liven	The process of operating switching devices to electrically connect an installation to a source of electricity and allow electricity to flow to an installation.

Load	Any equipment or appliance that consumes electrical energy to perform its intended function, e.g. a fridge or TV. This includes any electrical losses incurred during the process.
Load Management or Load control	Load management interrupts power to the nominated controlled load to reduce electricity demand temporarily in accordance with either the Distributor Agreement between Vector and the Electricity Retailer or other third-party agreement relating to load control. Load control is commonly used on residential electric-water heaters, but other loads could include irrigation pumps, pool pumps, electric vehicle charging, air conditioning units, storage space heaters and underfloor heating and other loads that may now or in the future be load controlled. Customers that agree to have their load managed may receive the benefit of a lower electricity tariff from their Electricity Retailer or third party Distributed Energy Resource (DER) manager. Vector may load control to mitigate network or grid security issues in accordance with the Distributor Agreement.
Low Voltage (LV)	Any voltage exceeding 50 Volts AC or 120 Volts ripple free DC, but not exceeding 1000 Volts AC or 1500 Volts DC.
Metering equipment	Equipment that measures electricity quantity, usually in kilowatt-hours at a half hourly interval. Equipment must meet the requirements of Electricity Industry Participation Code, part 10.
Overhead lines	Above ground conductors including its support structures used to transport electricity.
Paralleling	Arranging electrical loads with separate electrical pathways to the electrical supply.
PCBU	Person conducting a business or undertaking (as defined in the Health and Safety at Work Act 2015).
Point of Supply (POS)	<p>The Point of Supply is the point at which electricity equipment that exclusively supplies a property crosses that property boundary and:</p> <ul style="list-style-type: none"> • if there are both high voltage lines and a transformer owned by Vector on the property, the Point of Supply is the point at which electricity from the transformer enters exclusive fittings; or • if there are non-exclusive fittings on the property, the Point of Supply is the point at which those fittings become exclusive fittings; or • if the exclusive fittings on the property are owned by a customer that is a tenant or licensee of the owner or occupier of the property, the Point of Supply is the point at which those exclusive fittings enter the area leased or licenced by the owner; or • if there is a specific agreement (e.g. with Vector or a Retailer) that any other point on the property is the Point of Supply, the Point of Supply is the agreed point, • (as defined in the Electricity Act 1992). <p>However, for practical purposes, the Point of Supply is the isolating fuse located either on the boundary of the property or on the pole nearest to the property.</p>

	Please refer to section 6 to find where the Point of Supply is located in each type of configuration.
Prospective Short circuit current	Prospective short circuit current is the highest electric current that can exist in an electrical system under fault conditions.
Record of inspection (RoI)	Requirements for a record of inspection for electrical work is defined in Regulation 72 of the Electricity (Safety) Regulations 2010.
Residential area	Areas that are zoned residential in the Auckland Unitary Plan.
Residual Current Device (RCD)	A device for isolating supply to protected circuits, socket-outlets, or appliances in the event of a current flow to earth that exceeds a predetermined level.
Rural area	Areas zoned as rural in the Auckland Unitary Plan.
Service cable	An underground cable owned by the customer, that electrically connects the customer's switchboard to the Point of Supply.
Service connection	Is the cable or overhead line on the customer's property beyond Vector's Point of Supply
Service line	An overhead line owned by the customer, that electrically connects the customer's switchboard to the Point of Supply.
Service Pit or Pillar	A fitting on the Vector's LV distribution network which acts as the Point of Supply for customers supplied by an underground cable.
Switchboard	Consisting of a panel of mounted electric switches within a customer's installation, arranged so a number of circuits may be connected or disconnected.
Builders Temporary Supply (BTS)	A temporary connection usually required by builders or other tradespeople as an electrical supply at a worksite where there are no existing electrical network supplies available.
Volts (V)	Abbreviation for the measure of voltage.

1. Introduction

1.1 Purpose

The purpose of these Network Connection Standards (Standards) is to provide guidance on Vector’s technical requirements to allow the safe connection and operation of all electrical installations owned or operated by a customer. The Standards are applicable to all customers (including prospective customers).

1.1.1 Intended audience

These Standards are intended primarily for **Electrical Service Providers** and all **Customers** connected (or intending to be connected) to Vector’s electricity network. Sections address a particular audience as shown below:

Sections	Targeted audience	Content
1	Customers and Electrical Service Providers	Introductory sections that provide context for the Standard.
2-4	Customers	Important guidelines for customers to establish, change and maintain a connection to Vector’s electricity network.
5	Electrical Service Providers	Technical requirements for connections to Vector’s electricity network.
6	Customers and Electrical Service Providers	<p>The various types of connections to Vector’s electricity network, along with the ownership boundaries, responsibilities and specific requirements for each connection type. It is important that Electrical Service Providers and customers understand the configuration that is applicable to them as well as any specific requirements and responsibilities of these installations.</p> <p>Most of this section is not applicable to customers with simple residential or general connections.</p>

1.1.2 Scope of this Standard:

- Guidelines for customers to establish, maintain and modify connections to Vector’s electricity network
- Technical requirements for customer installations to be connected to Vector’s electricity network.
- Provide guidance on ownership boundaries and responsibilities between customers and Vector.

1.2 Who can carry out electrical work on private property?

The following Electrical Service Providers can carry out work on electrical installations:

- Registered Electricians,
- Registered Electrical Installers,
- Registered Distribution Line Mechanics,

- Registered Substation Maintainers, and
- Registered Cable Jointers.

For further guidance on the selection of Electrical Service Providers, please refer to section 2.3.

1.3 Health, Safety and Environment

Vector takes the safety of customers, employees, contractors and members of the public very seriously. Any work conducted on and around Vector’s equipment by external parties must be conducted in line with Vector’s policies. Vector will not allow connection of any customer installation to its network unless it has been issued with a Certificate of Compliance (CoC) by the registered electrician who completed the work. See section 5 for details on CoCs.

1.4 Summary of roles and responsibilities

Responsible Party	Technical Requirement
Electrical Service Providers	<ul style="list-style-type: none"> • Design and install equipment and fittings according to the latest legislation and best practices such as AS/NZS 3000, Electrical Codes of Practices, Electricity Act 1992, Electricity (Safety) Regulations 2010 and the Health and Safety at Work Act 2015. • Installation must have a Certificate of Compliance.
<i>(Employed by Customer)</i>	<ul style="list-style-type: none"> • Provide customers with technical support for their installation. • Maintain customer’s installation, including fault restoration.
Electricity Customer	<ul style="list-style-type: none"> • Maintain installation so that safety hazards are controlled. • Undertake mandatory periodic maintenance as per section 3.2 (special installations only). • Maintain minimum electrical clearance from Vector’s live equipment as per section 3.4. • If Vector’s equipment is installed on their property, they must provide unobstructed access to this equipment at all times as per section 3.5.
<i>(Property owner or occupier)</i>	
<i>Electricity Retailer</i>	<ul style="list-style-type: none"> • Install and manage customer’s metering. • Select the appropriate electricity tariff in respect of the customer. • Establish a contract for the delivery of lines services with the customer. • Charge the customer for energy and lines services.
<i>Vector</i>	<ul style="list-style-type: none"> • Manage the process for new connections or modifications to existing connections. • Manage Vector’s electricity network to deliver lines services.

2. Connecting to Vector’s Electricity network

This section details the process for establishing a new connection to Vector’s electricity network.

2.1 Summary of the application process for a new connection

The diagram below depicts a basic overview of the processes required to establish a new connection. For further details refer to: vector.co.nz/personal/get-connected.

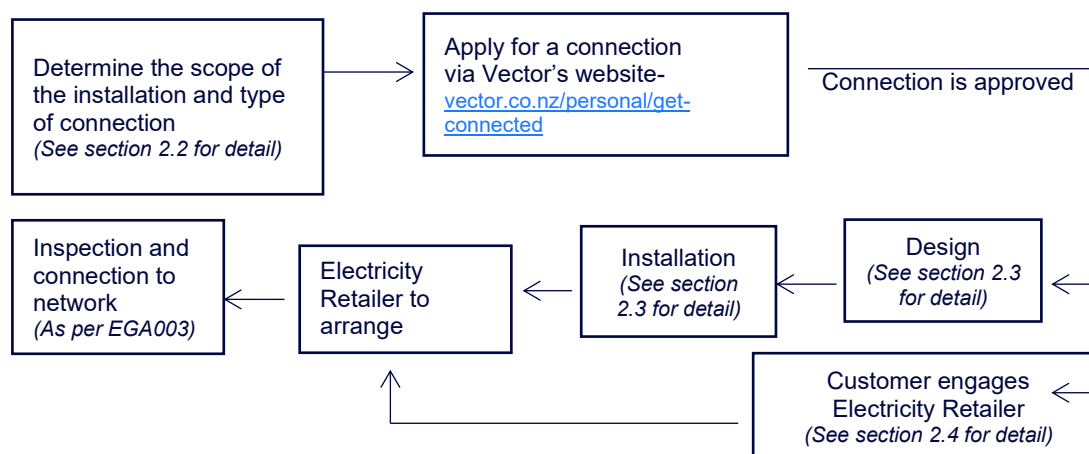

2.2 Determining the scope of the installation

Prior to applying for a connection on Vector’s [website](https://vector.co.nz), it is important the customer understands the requirements (capacity, solar, EV charger, large appliances, etc) of their electrical installation to ensure they are applying for the appropriate connection (for example, a residential connection or a commercial connection; a single-phase connection or a three-phase connection).

If a customer applies for the wrong connection type, this can result in significant delays and additional rework costs. For more information, please refer to sections 5 and 6 of this Standard.

In all cases it is recommended that the customer discusses requirements of the installation with the Electrical Service Provider carrying out the design of their installation prior to applying for a connection. The table below identifies specific requirements the customer may wish to discuss with their Electrical Service Provider.

The customer and their Electrical Service Provider are responsible for scoping and applying for the correct connection. The customer or the Electrical Service Provider (but not both) will make an application to Vector for the connection. Vector takes no responsibility for scoping the requirements of the customer’s installation or for metering or living the site.

Design consideration	Recommended actions
Expected electrical load	Discuss the requirements of electrical appliances with the Electrical Service Provider to estimate the load requirements of the installation, including any load diversity (not all load will be used at the same time) as per AS/NZS 3000 section 2.2.2. This information will determine the capacity to be made available on the network to meet the load requirements.
Does the customer plan on having any loads with special characteristics such as: welders, Electric Vehicle chargers, three-phase motors	These loads can cause interference on the network if the supply connection is inappropriate. In a residential situation, these loads need to be carefully designed to ensure:

<p>or single-phase motors over 1.5kW, or furnaces?</p>	<ol style="list-style-type: none"> 1) the switchboard and connection fuses are rated to handle the proposed load; 2) the network has the capacity to supply the proposed load; and 3) these special loads do not cause voltage disturbances to other customers. As per section 5 of these Standards, expensive remedial costs may result if the installation / load is found to cause disturbance to other customers. <p>If the customer plans on having these special loads, it is important that the customer discusses these with its Electrical Service Provider early in the application process.</p>
<p>Does the customer plan on having generators (such as solar panels or combine heat and power units) or batteries capable of exporting power onto Vector's electricity network, installed capacity over 100 Amps three-phase, or are you adding more load to a multi-dwelling complex or commercial business?</p>	<p>These installations have more complex installation requirements. It is very important that the customer discusses these requirements with its Electrical Service Provider before applying through Vector's website.</p> <p>Applicants considering connecting generation, including solar panels, must familiarise themselves with the process: vector.co.nz/personal/electricity/distributed-generation</p> <p>Applicants considering connecting battery storage must consult the following: vector.co.nz/personal/batteries/connecting-your-battery-to-our-network</p>
<p>Builder's Temporary Supply</p>	<p>If power is required for construction prior to a permanent connection being established, then a temporary connection may be requested. Requirements should be discussed with an Electrical Service Provider as soon as possible, in particular to establish how the temporary connection be migrated to the permanent connection at the end of the project. For information about the requirements of establishing a temporary connection, refer to section 2.5.</p>
<p>Route of service cables</p>	<p>Customers should discuss the route of their service cables with their Electrical Service Provider to ensure the route will not constrain any future construction plans, and to select a route where the customer is unlikely to dig up the cables or build over them in the future. The customer should provide a marked-up plan showing the route of any proposed underground services and location of their main switchboard for Vector to plan their work on site.</p>
<p>Connection of overhead service lines (Rural only)</p>	<p>Customers should discuss the different options for connecting their overhead service line to their house with their Electrical Service Provider. Where possible, the line should not be near trees or other areas where people, objects or vehicles are likely to approach them. In all cases, the clearance requirements of ECP34 must be complied with.</p>
<p>Sensitive loads</p>	<p>A sensitive load is electrical equipment that may malfunction due to voltage fluctuations that may be encountered during normal operation of the network.</p> <p>If the customer anticipates the load that is to be connected to the network is sensitive to voltage fluctuations, they should discuss this with their Electrical Service Provider to ensure mitigating measures are taken at the design stage. Refer to section 5 of this Standard for more information.</p>

<p>Does the customer plan on having a HV connection to Vector's electricity network?</p>	<p>It is important that the customer understands the mandatory health and safety, maintenance and operational obligations associated with owning HV installations. Meeting these requirements has an ongoing cost, including competency requirements for those workers carrying out work and any ongoing operations. Refer to sections 3.2.1 and 6.6 for further details.</p>
--	---

2.3 Guidelines for selecting Electrical Service Providers

The selection of qualified and suitable contractors and Electrical Service Providers for work on a customer's installation is the responsibility of that customer. A useful guide can be found on the Electrical Workers Registration Board website (ewrb.govt.nz) with more information on competency and scope of works found here: ewrb.govt.nz/working-safely-and-in-compliance/limits-of-work.

2.4 Guidelines for engaging with Electricity Retailers

Electricity Retailers have an important role in setting up a new connection to Vector's electricity network. They arrange:

- the metering installation;
- provisions for load management (if applicable); and
- the customer's pricing plan.

It is recommended that an Electricity Retailer is engaged as early as possible to prevent these processes delaying the connection.

Load management requires the use of non-intrusive devices to interrupt power to nominated appliances in the premises to reduce network peak demand. Customers that have load management devices installed on their premises may be eligible for a lower electricity tariff from their chosen Electricity Retailer. For information on the electricity tariffs, refer to the Power Switch website: powerswitch.org.nz/.

2.5 Applying for temporary builder's supply

Builders Temporary Supply (BTS) may be required during construction, and applications for the BTS can be made by calling Vector on 0508 VECTOR (0508 832 867) or at vector.co.nz/personal/electricity/new-connection/builders-temporary-supply. The following needs to be considered when applying for the BTS:

- Application for the temporary connection must be made prior to the application for the permanent connection. It is recommended to discuss requirements for the BTS with an Electrical Service Provider as early as possible.
- Main switchboards of the BTS must be located on the Customer's property and not fixed to Vector's electricity network equipment.
- Temporary connections are made at the discretion of Vector and subject to availability of capacity in the network.
- In some cases, temporary connections can become the permanent connection at the end of the project. The customer should discuss with its Electrical Service Provider to see if this option is possible.
- The customer is responsible for the full cost of establishing a temporary connection.
- Vector permits temporary connections for up to six months for the purposes of enabling construction works prior to the connection of a permanent supply. Should the need for the BTS

continue beyond the six-month period, the customer is required to make an application for the permanent supply from an Electricity Retailer.

- Temporary connections must be metered.
- Customers must advise Vector by calling 0508 VECTOR (0508 832867) when the BTS is no longer required or via vector.co.nz/decommissionicp.

3. Information for customers with existing connections

This section details guidelines for maintaining an electrical installation to prevent fire, safety incidents, compliance breaches and power outages.

3.1 What electrical equipment do I own and am responsible for?

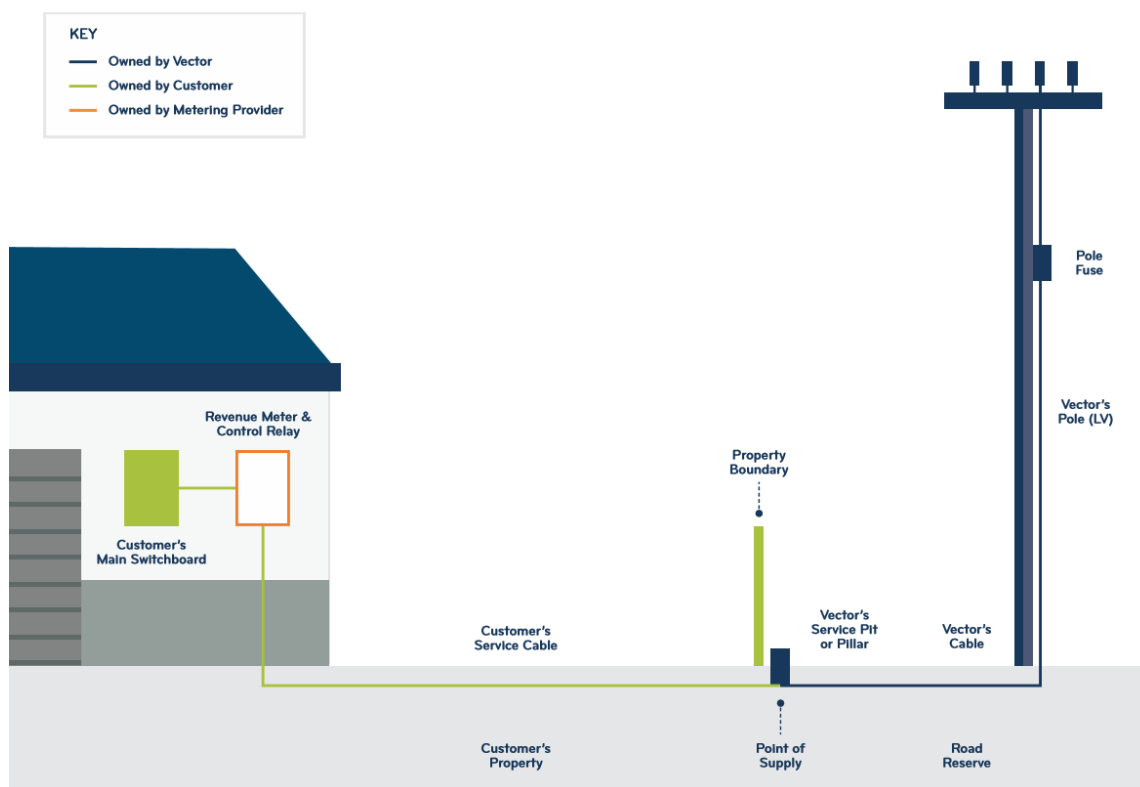

The diagram above shows a typical single dwelling that is connected to Vector's electricity network. For this type of connection, the customer owns and is responsible for the electrical equipment inside their property up to the Point of Supply.

The cost to repair or modify electrical equipment is the responsibility of the party that owns the equipment. For further details refer to: vector.co.nz/personal/electricity/what-you-need-to-know/line-ownership/

For customers with more complex connections to Vector's electricity network, refer to section 6 for details about the equipment they own and are responsible for.

3.2 Maintenance Activities

This section provides guidelines for the customer to establish a maintenance regime that is appropriate for their installation. For more comprehensive and up to date guidelines refer to: worksafe.govt.nz/topic-and-industry/electricity/installations-and-networks/

Note that the customer is responsible for the maintenance of their installation (equipment beyond the Point of Supply) and Vector takes no responsibility for this.

3.2.1 Mandatory routine electrical inspections for special installations

Certain special installations require mandatory routine inspections. For more information or further clarifications, refer to: worksafe.govt.nz/topic-and-industry/electricity/installations-and-networks/low-voltage-electrical-installations/inspection-and-periodic-verification/

Specific Installation	Installation details	Mandatory routine maintenance
Connectable installations	Connectable installations such as a vehicle, relocatable building, or pleasure vessels.	Connectable installations must not be hired or leased unless the connectable installation has a current warrant of electrical fitness. A warrant of electrical fitness must be issued by an authorised person. The specific requirements for a vehicle, relocatable building or a pleasure vessel can be found under the Electricity Safety Regulations sections 76 , 77 and 78 .
Electric vehicle (EV) chargers	The requirements for installing and connecting EV chargers are contained in the Guidelines for safe electric vehicle charging (worksafe.govt.nz/laws-and-regulations/regulations/electrical-regulations/regulatory-guidance-notes/electric-vehicle-charging-safety-guidelines/) and in SNZ PAS 6011:2021 and SNZ PAS 6010:2021.	The maintenance requirements for EV chargers are contained in the Guidelines for safe electric vehicle charging (worksafe.govt.nz/laws-and-regulations/regulations/electrical-regulations/regulatory-guidance-notes/electric-vehicle-charging-safety-guidelines/) and in SNZ PAS 6011:2021 and SNZ PAS 6010:2021.
High risk installations	High risk installations, as per the Electricity Safety Regulations section 75 , including: <ul style="list-style-type: none"> • Carnivals and fairgrounds • Caravan parks • Boat marinas • Demolition and construction sites • Hazardous areas • Medical facilities 	High risk installations must be inspected by competent persons in accordance with the Electricity Safety Regulations section 75 and the following codes of practices: <ul style="list-style-type: none"> • Caravan parks (see NZECP 1) • Boat marinas (see NZECP 29) • Hazardous areas (see NZECP 24) • Medical facilities (see NZECP 12)
High voltage installations	Any installation with equipment rated above 1000V AC or 1500 DC.	Implement routine safety checking systems as per the Electricity Safety Regulations section 40 and 62 .

3.2.2 Other routine maintenance activities

Although most installations do not have prescribed mandatory routine maintenance as detailed in section 3.2.1, customers must still meet their legal and health and safety obligations. In particular, customers can be prosecuted if they fail to meet their obligations towards the health and safety of the users or due to negligence. In addition to this, it is in the interest of the customer to have a proactive maintenance regime to mitigate the risk of fire and electric shocks. Therefore, it is suggested that the customer seeks advice to determine a maintenance regime that is appropriate for their installation by contacting:

- Electrical Service Provider – for residential and general customers connected to Vector's 400/230V network; or
- A HV Electrical Engineering Consultant – for commercial customers connected to Vector's electricity network above 400/230V.

Sections 3.3 – 3.5 detail some of the customers' requirements and obligations, for further details refer to worksafe.govt.nz/topic-and-industry/electricity/installations-and-networks/ or discuss with your Electrical Service Provider or HV Engineering Consultant.

To ensure their installation and equipment are in good working condition to provide a safe environment for the users, customers should arrange for routine inspections to be carried out on their installations, particularly the service cables and lines, their main switchboards and HV equipment.

Note that AS/NZS 3019 is a widely used standard for routine maintenance practices of low voltage installations. AS/NZS 3760 is another widely used standard for testing of appliances, which is commonly referred to as “testing and tagging”. NZECP50 details maintenance requirements for appliances. It is recommended that the customer discusses with their Electrical Service Provider whether the requirements of these standards are applicable to the customer’s installation.

3.3 Managing the risk of digging into service cables

Customers must always follow safe digging practices. If digging or excavation is proposed inside a customer’s property and the location of the service cables is unknown, then it is strongly recommended that the customer contacts its Electrical Service Provider for advice as to where it is safe to excavate. For further guidelines about managing this risk, refer to Worksafe’s guidelines for excavation safety: [worksafe.govt.nz/dmsdocument/17-excavation-safety](https://www.worksafe.govt.nz/dmsdocument/17-excavation-safety) and vector.co.nz/blob/vector/media/vector/cac-guide-review-_updated180818.pdf

3.4 Restrictions for working or building near Vector powerlines

Buildings and structures must always be outside of the minimum safe distances for electricity networks. The consequences of building structures within the minimum safe distances of live electrical conductors are severe and life threatening. Vector’s powerlines carry up to 110,000 volts. Approaching these lines carries a huge risk of fire and electrocution. [ECP 34](#) defines the minimum approach distances to electrical conductors and their supporting structures (e.g., poles and towers). Breaching these limits can also result in prosecution.

If there is any doubt about the minimum safe distances from live conductors, contact Vector on 0508 VECTOR (0508 832 867). Further information can be found on vector.co.nz/personal/help-safety/near-our-network/building-near-overhead-lines.

From time to time, Vector must maintain its overhead line equipment. Carrying out such maintenance activities will often require entry to the land beneath the overhead lines. Landowners should avoid constructing structures, planting trees or stacking objects beneath the overhead lines.

3.5 Responsibilities for customers with Vector equipment on their premises

All equipment owned by Vector installed after 1993 in land other than the road reserve may require an easement (see section 5.11) and includes certain installations inside private property (including customer owned land) and public property (being Council owned and administered land, including Reserve land, and Crown owned and administered land).

Vector has a standard form of easement instrument to be used for all easements (in gross) and this easement instrument is registered on a record of title to the land. The terms of the easement allow Vector’s equipment to legally occupy the area defined by the easement, in perpetuity, and provides for Vector to have unobstructed access at all times to its equipment in order to operate and maintain it. Easements also require that there is reasonable unobstructed space around the equipment to ensure safe operation and access to carry out any necessary maintenance and repair work. Vector has standard easement areas required for all types of equipment.

Vector, the customer’s Electrical Service Provider and the customer are responsible for their obligations under the Health and Safety at Work Act 2015.

If a customer breaches the terms or conditions of a Vector easement registered over their property title (such as by building over the land covered by the easement or obstructing access to the equipment) then they may be liable to pay for any work necessary to remedy the breach. It is important that the customer understands the terms and conditions of the easement to avoid breaching the terms. It is also important that when a customer purchases a property with an easement in favour of Vector registered over the title, that the customer make themselves fully

aware of the terms of the easement and their obligations under the easement. Easement terms, conditions and obligations remain on the record of title indefinitely and carry over from the previous owner.

If there is equipment owned by Vector on a customer's property which was constructed before 1 January 1993 (when the Electricity Act 1992 was enacted) then in some cases there will be no need for an easement. In these cases, Vector's right to enter the land to operate and maintain the equipment is very similar to the terms and conditions of an easement. Section 23 of the Electricity Act gives Vector the right to "enter upon land for the purpose of gaining access to those works and may perform any act or operation necessary for the purpose of inspecting, maintaining, or operating the works".

For any further clarifications regarding Vector's standard access and easement requirements, contact 0508 VECTOR (0508 832 867).

3.6 Vector to inform WorkSafe of electrically unsafe installations

Should Vector or its field service providers become aware that an installation is electrically unsafe, they will notify the owner of the installation and WorkSafe of the situation (refer to Reg 15 of the Electricity (Safety) Regulations). WorkSafe will take any appropriate and necessary actions to ensure safety.

3.7 Planned interruptions

From time to time, Vector may need to temporarily restrict or disconnect a customer's power supply to carry out repairs, maintenance or alteration to the network. These situations are infrequent and where reasonably practical, Vector will seek to minimise disturbance to the customer. To ensure they are prewarned of planned works, customers are encouraged to register their email address and mobile phone number with Vector: vector.co.nz/preferences

4. Information for customers modifying their connections

This section details guidelines for modifying connections to Vector's electricity network.

4.1 Requirements for customers increasing their capacity

If a customer wishes to increase their load to an extent that requires their switchboard to be updated, then they'll need to engage a registered electrician to carry out this work. A Vector field service provider will be required if this work involves working on the Vector network (for example, connecting a larger capacity service cable to a new service pit). In addition to this, the customer or their Electrical Service Provider, must also lodge a load change request to Vector by calling 0508 VECTOR (0508 832 867).

Customers must lodge the change request before upgrading an installation, as this allows Vector to confirm the new installation is compliant and whether or not Vector's network needs to be modified. This is to ensure there is sufficient network capacity and the customer's installation is safely protected. If an installation is upgraded without lodging a change request with Vector, this could result in significant additional rework costs, delays and non-compliance penalties for which the customer may be liable.

4.2 Requirements for disconnecting from Vector's electricity network

If a customer wishes to disconnect from Vector's electricity network, they must lodge a disconnection request through Vector's website at vector.co.nz/decommissionicp or call Vector on 0508 VECTOR (0508 832 867).

4.3 Requirements for reconnecting to Vector's electricity network

Requirements for reconnections are subject to Section [74](#) of the Electricity (Safety) Regulations and may require retesting and inspection. It should be noted that if an installation was disconnected for more than six months, an inspection will be required before it can be reconnected to the network.

5. Technical design requirements

This section details technical requirements for new or modified connections to Vector's electricity network. It is important that Electrical Service Providers understand these requirements and how to implement them.

5.1 General requirements

All electrical installations must meet the requirements specified in the latest revisions of:

- New Zealand Electrical Codes of Practices
- Electricity (Safety) Regulations 2010
- AS/NZS 3000:2007 (Australian / New Zealand Wiring Rules)
- Other standards referenced in this Standard

5.2 Vector's system of supply

This section contains Vector's electricity network parameters. Customers should use these as reference when designing their installations and purchasing their appliances to ensure proper and safe operation of their equipment and appliances.

5.2.1 Voltage

Vector offers single-phase and three-phase supply options.

- Most residential and general customers are supplied by 230V single-phase supplies. Some residential customers with larger capacity requirements may choose a 400V three-phase supply.
- Commercial customers may choose either a 230V single-phase or 400V three-phase supply from Vector's low voltage network.
- Larger commercial customers may choose to have their 400V three-phase supply from a transformer installed on their premises. The transformer is either connected to Vector's 11kV or 22kV network.
- Customers with very large capacity requirements who wish to own their transformers may request their supply to be made at 11kV or above (including 22kV and 33kV).

For customers supplied at 230V single-phase or 400V three-phase, they can expect their voltage to be maintained within +/-6% of the nominal voltage, except for momentary fluctuations. For customers supplied at 11kV or above, unless agreed otherwise, they can expect their voltage to be maintained within +/-6% of the nominal voltage, except for momentary fluctuations.

5.2.2 Earthing

Customers (except for supply to low voltage AC railway signalling equipment) connected to Vector's low voltage network or dedicated transformers are required to design and construct their installations to a multiple earth neutral system.

5.2.3 Frequency

Vector's electricity network is connected to the national grid, owned by Transpower NZ. The supply frequency is synchronised with the national grid, which is monitored and controlled by Transpower

NZ (the System Operator). Except for momentary fluctuations, the customer can expect the frequency to be kept within +/-1.5% of 50Hz.

5.2.4 Prospective short circuit current

Vector is required to take reasonable steps to ensure the maximum prospective short circuit currents on the supply system are limited to reasonable levels as required by Reg 30(1)(b) of the Electricity (Safety) Regulations 2010.

For commercial customers connected to dedicated transformers, the prospective short circuit current for the respective installation is predominantly determined by the size and impedance of the transformer. Typical prospective short circuit currents at the LV terminals of the different sizes of transformer used in Vector's network are published in Appendix B of this Standard. Customers should ensure that their installation is sized to operate safely with these prospective short circuit currents and protective devices are correctly configured to provide the necessary protection discrimination.

For customers connected to the low voltage network, Vector will maintain the prospective short circuit current to no more than 5kA.

5.3 Quality of supply

To preserve the quality of electricity supplied, customers must not use equipment or appliances that would unduly interfere with the satisfactory supply of electricity or impair the safety or operation of equipment and appliances of other customers. This section contains the standards customers' equipment and appliances are required to comply with.

Customer power quality must comply with all relevant NZ Electricity Regulations, NZ Electrical Codes of Practice and AS/NZS 61000 series of Standards and Technical Reports.

Where AS/NZS 61000 series references are inadequate, then customer power quality must adhere to IEC 61000 series of Standards and Technical Reports. The EEAs (Electricity Engineers Association of New Zealand) Power Quality (PQ) Guidelines may be used as a guide.

If a customer's equipment causes excessive power quality disturbances, the customer may be required to bear the remedial costs.

5.3.1 Voltage imbalance

Installation of inverter based energy sources should be carefully designed to avoid voltage imbalance. Reference should be made to AS/NZS 4777.1-2016.

5.4 Service connections

Each customer installation connected to Vector's network will be identified by a unique identifier called an Installation Control Point (ICP). After it is established, the ICP is used as the identifier for the purposes of load management, metering and billing by the Electricity Retailer. The ICP remains with the connection rather than with the customer. There are specific requirements applied to each ICP. Within the customer's premises there must be a means of; disconnecting (isolating) their installation from Vector's network, providing electrical protection for the installation and providing metering equipment.

Isolation is generally provided through a master switch or circuit-breaker located on the customer's main switchboard (see AS/NZS 3000). In some cases where the customer is supplied from more than one source (for example, from two transformers), more than one master switches or circuit breakers on the customer's main switchboard may be installed to provide the means of isolation. Smaller capacity supplies may be protected by fuses, while larger capacity supplies will be protected by circuit breakers.

For safety reasons, there will generally be only one connection (one ICP) to the network, per installation. Any deviation from this must be approved by Vector.

In urban areas, new residential and general service connections will be via an underground cable from a service pit or pillar located at the front boundary of the property, or where Vector's network is overhead, the service cable may be terminated onto a pit or pillar supplied from the overhead line. For larger capacity connections onto the network, the customer or their Electrical Service Provider should contact Vector on vector.co.nz/personal/get-connected or by calling 0508 VECTOR (0508 832 867) for more detailed information.

In rural areas, service connections are assessed on a case-by-case basis. Contact vector.co.nz/personal/get-connected or call 0508 VECTOR (0508 832 867) for more information on the connection process.

5.4.1 LV Connections

LV connections are taken from the low voltage network in the street. Connections to this network are generally via a service pit or pillar which contains a set of fuses installed by Vector to protect the service cable against electrical faults. The customer is also required to install separate protection in their main switchboard to protect the downstream installation and not rely on Vector's protection. For new connections, the customer's Electrical Service Provider will install a service cable to the service pit or pillar, with the final connection into the pit or pillar to be arranged by the Electricity Retailer and completed by Vector's approved livening inspector. The Electricity Retailer will also arrange to install the metering equipment upon satisfactory inspection of the installation. For safety reasons, access to the service pit or pillar by the customer or their Electrical Service Provider is not permitted.

In some cases when larger capacity supplies (in excess of 100A three phase) are installed, current transformer metering may be required. The customer's Electrical Service Provider should liaise with the Electricity Retailer regarding any metering equipment that may be required for their installation.

5.4.2 Substation Connections

For a very large load, such as that for a commercial/office complex or industrial building, a dedicated supply is often required. For loads larger than 100kVA, a substation may be required to accommodate an 11kV/LV (or 22kV/LV) transformer in order to connect to the 11kV (or 22kV) distribution network to provide the necessary capacity for the customer. The transformer converts the 11kV (or 22kV) supply to 230/400V to supply the customer. LV service cables will be installed by the customer from the LV frame of the transformer to the customer's main switchboard. The Electricity Retailer's inspector will install the metering equipment, inspect the installation and issue a record of inspection before the Vector-authorized person terminates the cables to the transformer LV frame and liveness the supply. Note that in this situation, the Point of Supply is at the connection of the service cables to the transformer's LV frame.

Before the installation is livened by Vector, the customer's Electrical Service Provider will have completed the electrical checks required under AS/NZS 3000, ensured the Electricity Retailer's metering equipment has been installed and provided a Certificate of Compliance to confirm the installation is safe to live.

Where multiple connections to a site have been approved by Vector, they must not be operated in parallel. This is to ensure the safety of personnel working on Vector's network as well as to prevent excessive prospective short circuit current passing through the customer's installation, potentially causing equipment damage.

5.4.3 HV Connections

Some large customers may prefer to own the transformers supplying their premises. In those cases, the customers will receive supply at 11kV or above (including 22kV and 33kV). Connection options include:

- Vector nominates one of its nearby substations and installs an HV cable to supply the customer's transformer on the customer's premises. If there is more than one transformer on site, the customer will install (and own) an HV switchboard to connect their transformers.
- Vector installs a new HV switchboard (or ring main unit (RMU)) close by the customer's premises and installs an HV cable to supply the customer's transformer on the customer's premises. If there is more than one transformer on site, the customer will install and own an HV switchboard to connect their transformers.

In both cases, the Vector-owned switchboard (or RMU) will form an integral part of the distribution network. If the Vector-owned equipment is located inside the customer's premises, an easement in Vector's favour will be required. The connection of transformers to the Vector-owned switchboard (or RMU) will be carried out by Vector's field service providers. All work downstream of the customer-owned switchboard or transformer connection point will be the responsibility of the customer. The Electricity Retailer will arrange installation of the metering equipment upon satisfactory inspection of the installation by their own inspector. Vector's field service provider will live the transformer upon receipt of the CoC, ESC and ROI of the installation.

It is important that the customer's HV consultant coordinates the protection settings of the installation with the settings of Vector's network to ensure safe and efficient operation of the network and the customer's installation. Vector will coordinate the protection settings within its network and with Transpower's national grid.

5.4.4 Overhead LV Service Lines

In rural areas, new connections may be made via overhead service lines using existing overhead distribution network at the property boundary.

Unless an alternative arrangement is made with Vector (in writing), lines and poles beyond the Point of Supply on the customer's premises are the responsibility of the customer (refer to the diagrams in Section 6 below). For LV residential or general service lines, this includes the connection fittings onto the house or building.

The overhead connections to Vector's poles must not impose forces beyond what the pole can safely withstand. Guidelines for this are contained in Appendix D of AS/NZS 3000. For more detailed information parameters for connecting to Vector's overhead lines, contact 0508 VECTOR (0508 832 867).

Vector requires that all phase conductors of LV overhead lines, including the neutral within the customer's premises, are insulated. Where appropriate, a LV neutral-screened service cable should be used for enhanced safety.

To ensure personal and public safety, and to avoid damaging the integrity of the service line, the owner must ensure that clearances between the service line and structures or vegetation are maintained in accordance with ECP 34 and AS/NZS 3000 (Table 3.8).

Earthing arrangement must be installed to meet the requirements specified in Section 5 of AS/NZS 3000.

5.4.5 Underground LV Service Cables

All new connections in residential areas are to be made by underground service cables via Vector's pits or pillars. The service cable from the Point of Supply to the customer's main switchboard is owned by the customer.

Suitably rated cable must be selected to achieve the required electrical capacity and voltage regulation of the installation. Appropriate cable type and size should be used to ensure adequate protection and to achieve the designed capacity.

Cables must be installed in accordance with the requirements of AS/NZS 3000, particularly the minimum installation depth, marker tape (where required), minimum conductor size and other mechanical protection requirements.

Earthing arrangement must be installed to meet the requirements specified in Section 5 of AS/NZS 3000.

5.4.6 *Service pits or pillars*

Service pits or pillars are junction boxes that allow the connection of customers' service cables to Vector's low voltage network.

Service pits or pillars will be installed by Vector's field service provider. Prior to connecting customers' service cables to Vector's network, the installation must be inspected, and the connection carried out by a Vector approved livening inspector selected by the Electricity Retailer.

In residential areas, the service pits or pillars are generally placed on the street frontage at the junction of two adjacent properties allowing the pits or pillars to service several customers.

Where a subdivided lot is more than 10 meters from an existing service pit or pillar, a new service pit or pillar must be established at the property boundary.

Service pits or pillars are designed and installed by Vector. For safety reasons, access to the service pit or pillar by the customer or their Electrical Service Provider is not permitted.

5.5 Electrical Protection

Electrical protection in an installation provides a means of identifying and disconnecting faulty electrical equipment before damage occurs that could result in risk to personnel and/or property. To meet this requirement, the customer's installation should be designed to meet the protection requirements in AS/NZS 3000.

When an electrical fault occurs within a customer's installation, the installation will be subjected to both heavy electrical currents and large mechanical stresses. These can be limited by the correct use of protection equipment to isolate the fault, but it is also necessary to ensure the electrical equipment is appropriately rated to withstand the fault currents under these situations without damage.

The largest current likely to flow within the installation under fault conditions is called the "prospective short circuit current". The short circuit rating of all customers' electrical equipment must be greater than the prospective short circuit current of Vector's network to which it is connected. This mitigates the risk of fire, significant electrical damage and personnel safety risk when an electrical fault occurs. The prospective short circuit current of Vector's network is largely determined by the characteristics of the upstream distribution transformers and their protective fuses that supply power to the customer.

For residential premises, the fault level will be maintained below 5kA by Vector with the use of fault limiting HRC fuses. For commercial customers, the fault level may be higher depending on the size of the transformer supplying the installation and the applied protection. This information is site specific but is available on request by calling 0508 VECTOR (0508 832 867).

5.5.1 *Protection*

Vector provides protection on its network and at the Point of Supply to the customer against fault situations. It is the customers' responsibility to provide protection against faults or overloads that may occur on their installation.

To ensure the safety of personnel and property, the customer must have electrical protective device(s) on their switchboard that will:

- Protect the installation against overcurrent situations
- Ensure any overcurrent protective device discriminates with Vector's protection.
- Clear any electrical faults within their installation before Vector's protection devices operate.

Depending on the situation, the protection may be afforded by a fuse or a protective device integrated into a circuit-breaker. For residential situations, the protection is generally provided by a 60A high rupturing capacity (HRC) fuse.

For larger capacity installations, the protection may be built into the mains circuit-breaker.

Where the customer's primary electrical protection is contained within a circuit-breaker, then the protection controlling the circuit breaker must be configured to:

- Ensure the protection will operate to prevent the customers' equipment, including cables, from overloading
- Discriminate with Vector's upstream protection
- Ensure the short-circuit rating of the customer's electrical equipment is not exceeded

Customers supplied from dedicated transformers require their protection to operate at an overcurrent limit no more than the electrical capacity of the transformer. The customer's load must not exceed the rating of the transformer. Vector may review the customer's protection schemes from time to time to ensure safe operation of Vector's equipment.

5.6 Supply capacity

All connection applications and capacity upgrade requests will be checked to confirm the requested supply capacity is available in Vector's network. Connection applications, variations to existing supplies or additional information may be submitted through Vector's website: vector.co.nz/personal/get-connected or vector.co.nz/business/get-connected.

5.6.1 Supply capacity – residential and general (<100A)

Most residential connections can be adequately supplied from a 60A single-phase connection from Vector's LV distribution network via pits or pillars. For power requirements in excess of this, a 60A three-phase supply, 100A single or three-phase supply may be needed.

When assessing the supply requirements of an installation, consideration must be given to the following:

The fault rating of the equipment that will be used on site. Vector will keep the prospective fault current at residential premises within 5kA. Any electrical equipment or protection devices must be capable of withstanding the fault currents to which it is exposed.

- The actual load that is to be supplied. While adding up the power requirements of all appliances offers an assessment of the potential total demand, not all equipment will be operating at the same time. The ratio between installed load and actual demand is called "diversity factor". AS/NZS 3000 Appendix C outlines the methodology for assessing diversified demand of an installation. When assessing the capacity requirements for the installation, Vector is interested in the "diversified" load. Prudent headroom should be made for future load increases while taking into consideration improvement in efficiency for new appliances. Oversizing the installation may result in unnecessary costs to the customer.
- Voltage drop is normally not an issue in urban areas. There may, however, be occasions when customers situated at the end of distribution lines – e.g. down long right of ways – experience excessive voltage drop. Conductors of adequate sizes must be used to prevent excessive voltage drop.

5.6.2 Supply capacity – Rural residential and general (<100A)

For situations where overhead service connection is allowed (as described in Section 5.4.4 of this Standard) the source of supply may be any one of the following:

- Vector's existing LV network (if capacity is available and voltage drop is acceptable)
- extending Vector's LV network (with associated network rearrangement if required)
- install a new transformer supplied from Vector's HV network, or
- upgrade an existing transformer

However, the relatively long distance between rural customers may mean that the most economical supply option is the installation of a new transformer supplied from Vector's HV network.

Where Vector's network is installed in private or public property, an easement (in gross) may be required to ensure Vector can access and maintain the equipment supplying the customer. The Electricity and Gas Easements Policy (UPA006) sets out when an electricity easement is required for new equipment installed in private or public property. may be required to ensure Vector can maintain the equipment supplying the customer. The ownership arrangement of this supply configuration is shown in Section 6.3 of these Standards.

Further information can be found on vector.co.nz/personal/get-connected

5.6.3 Supply capacity – Rural subdivisions

Rural lifestyle blocks generally use higher loads than the typical urban residential dwelling. A minimum of three-phase 60A supply is required for each dwelling in rural underground subdivisions.

For lifestyle blocks that are allowed to further subdivide under the Auckland Unitary Plan zoning, a higher capacity supply may be required depending on the level of allowable subdivision. The customer should discuss this with Vector (together with available information regarding zoning, size of sections, etc).

5.6.4 Supply capacity – Commercial

Applications for commercial connections or capacity upgrades are individually assessed to ensure the capacity request is reasonable and is available from Vector's existing network. If insufficient capacity is available, a network upgrade will be required. The assessment process follows these steps:

- A review of the capacity available from Vector's existing LV network
- Upgrading Vector's LV network to deliver the capacity
- Consider HV options including installation of a substation to meet demand

The assessment must take into consideration load diversity. AS3000 (section 2) provides guidance to assess load diversity. While dependent on the assessments above, as a general guide, diversified load over 100kVA could be a candidate for a new transformer. Vector will evaluate that the options are technically acceptable. The customer should note that if the diversified demand has been overestimated resulting in larger than necessary equipment being installed, the customer will be required to bear the cost of downgrading.

Where a new transformer is required, Vector may require the customer to provide a site for the substation within their property. Where a site is within the customer's property, an easement in favour of Vector will be required, in addition to clear and unobstructed access at all times to the substation for operations and maintenance.

Further information can be found on vector.co.nz/business/get-connected

5.6.5 Prospective short circuit rating – Commercial

In general, the prospective short circuit current in a commercial installation depends on the number and sizes of transformers supplying it. The customer must ensure adequately rated equipment is installed to handle any prospective short circuit current that may arise.

5.6.6 Parallel operation of transformers – Commercial

Vector does not recommend parallel operation of transformers as this will increase prospective short circuit currents in the customer's installation and create complexity in equipment protection.

Parallel operation of a transformer does not improve the security of supply to the installation, as the probability of failure of circuits supplying the transformer far exceeds that of the transformer. The effect of having multiple transformers supplying a site is to increase the capacity of supply. The increase in supply capacity can be achieved without having to operate the transformers in parallel.

If the customer requires the Vector-owned transformers to be operated in parallel, the only configuration acceptable to Vector is for two transformers to form a group as follows:

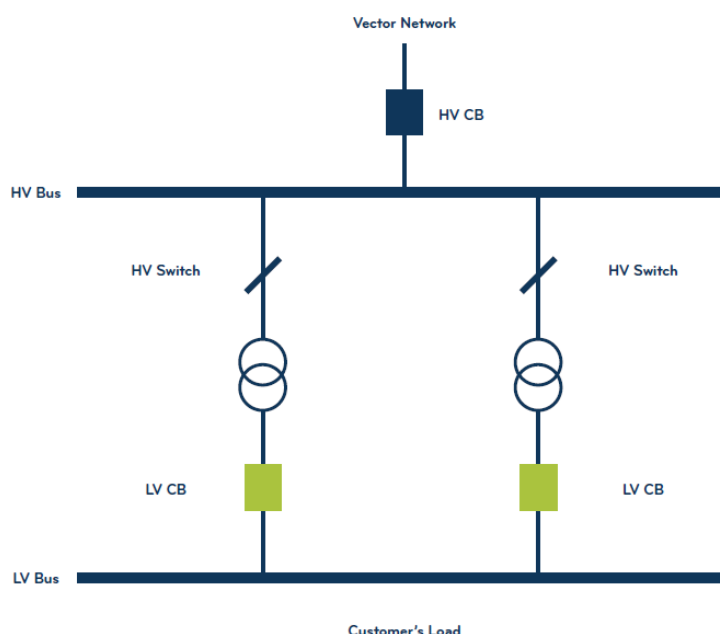

If more than two transformers are required, more groups of two will be required.

Alternatively, the customer may choose to own their transformers and arrange their own protection schemes.

If the customer requires enhanced security, they need to discuss this with Vector as the solutions will be site specific.

5.7 Earthing

Customers' earthing systems must be designed and installed in accordance with AS/NZS 3000. Vector's earthing in its network is designed and constructed to Vector's standards ESE501 (distribution substations in buildings) and ESE506 (distribution earthing), ECP 35, and Electricity (Safety) Regulations 2010.

It should be noted that New Zealand adopted a Multiple Earthed Neutral system of supply. The customer is required to install their own main earthing system in accordance with the requirements as set out in section 5 of AS/NZS 3000.

5.8 Metering

5.8.1 LV Metering – residential and general customer ($\leq 100A$)

Each ICP must be metered for revenue purposes. Metering must be arranged through the customers' chosen Electricity Retailer. Metering must be kept within the customers' installation, not on Vector's equipment.

Vector has a strong preference that external meter boxes be installed on new dwellings/buildings which will require whole current meter(s) to be installed and lived onto Vector's Electricity Network.

Metering enclosure size shall be sufficient to accommodate the metering equipment with or without the control devices. As a guide the following minimum space within the enclosure is applicable (minimum internal dimension):

- Single phase installation – 425mm Height x 355mm Width x 120mm Depth

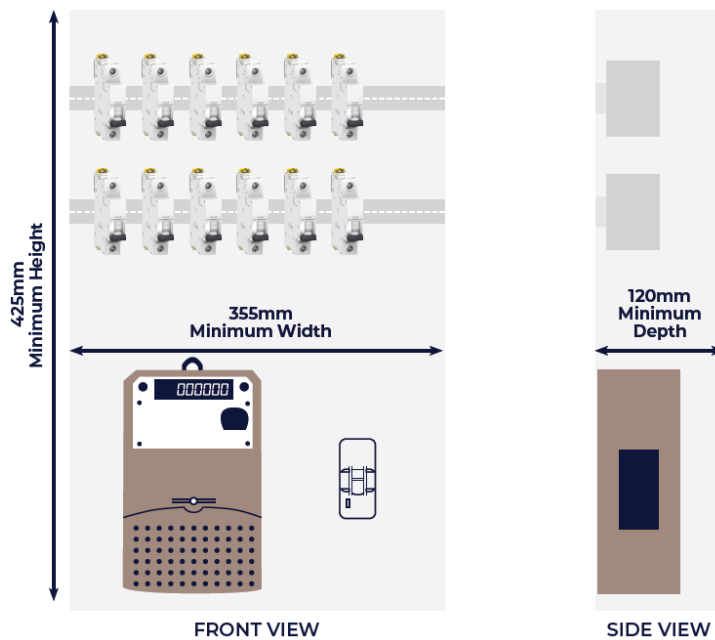

- Multi-phase installation – 500mm Height x 355mm Width x 120mm Depth

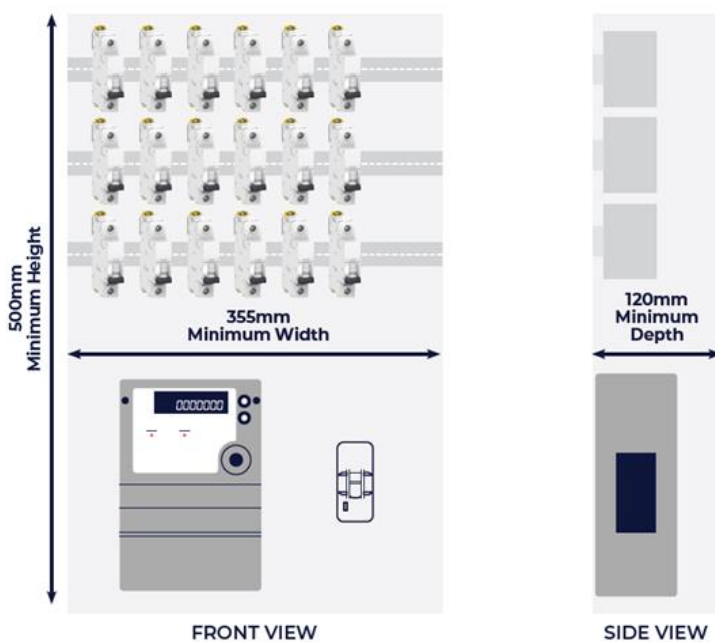

For instances where customers have suitable controllable load (i.e. electric-water heater with storage capacity greater than 50L heated with an element greater than 1.2kW) the controllable circuit must be wired into a separate controllable element of the meter, which may be internal to the meter (preferred, see simplified figure below) or an external relay (exception).

If applicable, other controlled load such as irrigation pumps, pool pumps, electric vehicle charging, storage space heaters and underfloor heating must not be wired into the same controllable element as the electric-water heater circuit. Refer to Vector's Smart Metering Guideline for further information, and the metering equipment provider (MEP) for meter documentation (i.e. wiring drawings).

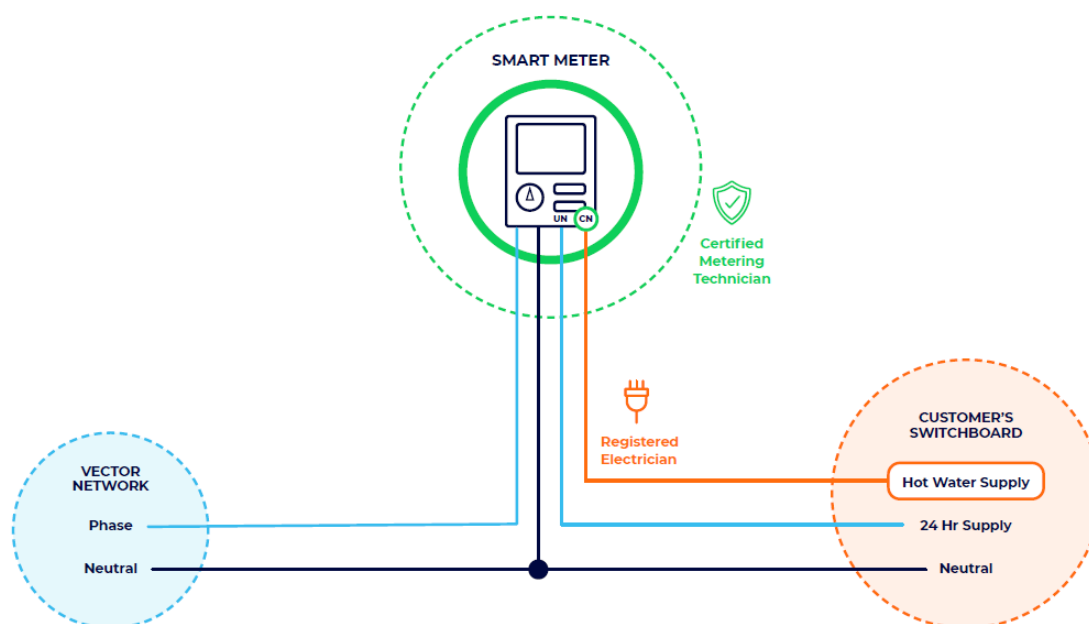

5.8.2 HV Metering – commercial customer (>100A)

For metering large quantities of energy, the preference is to use LV metering instead of HV metering which can be installed on the customers' main switchboard.

Where HV metering is unavoidable, the HV metering unit must be installed separate from Vector's HV switchboard. Any HV metering system must be arranged through the Customers' chosen Electricity Retailer. The customer should raise the prospect of HV metering at the earliest stage of the development with the Electricity Retailer. All costs associated with the HV metering unit, including but not limited to initial capital cost, ongoing maintenance and recalibration and end-of-life replacement, are solely the customer's responsibility.

It is mandatory for all new and existing commercial customers with a capacity greater than 69kVA (i.e. 100A) to be on the Time Of Use (TOU) tariff with metering capable of recording half hourly data which contains at least two of the following channels; kWh, KVArh, kVAh.

Commercial non-TOU plans will only be available for existing customers (as at 30 March 2022) that did not have the metering capability required as at 30 March 2022 and have a capacity of less than or equal to 345 kVA. If the capacity is greater than 345 kVA and the customer does not have the metering capability, then the customer must either reduce their connection capacity to 345 kVA or lower; or install metering capable of recording half hourly data.

5.8.3 Unmetered supplies

Unmetered supplies are only accepted where capacity is less than 1kVA and consists of fixed wired equipment with a predictable annual electricity usage.

5.9 Network Disturbance

To limit the effects of voltage waveform distortion and other disturbances on Vector's network caused by certain types of customer equipment, the customers' load must comply with the following:

- voltage and current waveform distortion must comply with the limits set out in all relevant Regulations, Rules, Electrical Codes of Practice and 61000 series joint Australian / New Zealand EMC standards; and
- the voltage and current waveform distortion by any load or customer installation must comply with:
 - AS/NZS 61000.3.2:2007 Electromagnetic compatibility (EMC) Part 3.2 Limits – Limits for harmonic current emissions (equipment input current less than or equal to 16 A per phase);
 - AS/NZS 61000.3.4 Electromagnetic compatibility (EMC) Part 3.4 Limits – Limitation of emission of harmonic currents in low voltage power supply systems for equipment with rated current greater than 16 A; and
 - AS/NZS 61000.3.6 Electromagnetic compatibility (EMC) Part 3.6 Limits – Assessment of emission limits for distorting loads in MV and HV power systems (IEC 61000-3-6:1996, MOD)
- Voltage fluctuations and flicker due to any load or equipment (e.g., motor starting, motor operation, sudden switching of large loads or equipment, operation of electrical arcing equipment such as welding machines or arc furnaces, etc) must comply with:
 - AS/NZS 61000.3.3 Electromagnetic compatibility (EMC) Part 3.3 Limits – Limitation of voltage changes, voltage fluctuations and flicker in public low-voltage supply systems, for equipment with rated current less than or equal to 16 Amp per phase and not subject to conditional connection.
 - AS/NZS 61000.3.5 Electromagnetic compatibility (EMC) Part 3.5 Limits – Limitation of voltage fluctuations and flicker in low-voltage supply systems, for equipment with rated current greater than 16 Amp.
 - AS/NZS 61000.3.7 Electromagnetic compatibility (EMC) Part 3.7 Limits – Assessment of emission limits for fluctuating loads in MV and HV power systems (IEC 61000-3-7:1996, MOD).

Vector may require a customer to implement corrective measures to limit the level of distortion, at their own expense, if their equipment does not comply with the above requirements. Under exceptional circumstances, Vector may consider other limits or levels.

Under fault and circuit switching conditions, the voltage may fall or rise transiently. The fall or rise in voltage will be affected by the method of earthing of the neutral point of Vector's network - the customer must take this into account when selecting their equipment.

The power factor of a customer's load measured at the meter shall not be less than 0.95 (lead or lag). Vector may require a customer to provide necessary corrective measures, such as power factor correction, at their own expense, if the power factor falls outside the 0.95 lead/lag limits.

Capacitors are generally installed in customer installations to provide power factor correction. Where capacitors are installed, they must meet the following requirements:

- Customers are allowed to install unblocked capacitors with a kVAr capacity of up to 2% of the connection kVA capacity.
- Capacitors that have a kVAr capacity that exceeds 2% of the connection kVA capacity must have suitably rated blocking chokes on the network side of the capacitors or group of appliances containing capacitors.

Capacitors connected to customer premises must not interfere with the propagation of ripple load control signals transmitted over Vector's network. These frequencies are 1050Hz and 475Hz.

5.9.1 Radio interference

Customer's installation and appliances must not cause interference with radio signals as per the Radio Communications (EMC standards) Notice 2015 and New Zealand Radiocommunication Regulations (32).

5.10 Signalling

Vector's network must not be used by customers to convey signals unless prior written approval is given by Vector. Any in-home devices (such as Wi-Fi extenders or baby monitors) used by the customer must meet the EMC requirements under the Radio Communications Act and must not cause signal spill over and interfere with the operation of Vector's network.

Where Vector has permitted signalling over its network, it does not take responsibility for the characteristics of its network to enable propagation of the customer's signal and the customer is responsible for installing suitable blocking filters to ensure the signal does not interfere with Vector's load management signals, the network or other customers' installations.

At any time, Vector may require that the signalling is removed from the network or corrective measures put in place to mitigate its impact to other systems, at the customer's cost.

5.11 Easements

If Vector's equipment is located within private or public property, the landowner may be required to grant Vector an easement (in gross) covering the space in which Vector's equipment is situated and access to equipment by Vector personnel to enable Vector to carry out its operation, maintenance and repair works. Mandatory electricity easement requirements are set out in UPA006.

Vector's equipment located on private or public property must have clear and unobstructed access at all times for operation, maintenance and repair purposes.

5.12 Generators

Applications for the connection of generators to Vector's network either directly (such as a standalone wind generator) or via the customer's installation (such as rooftop solar panels and/or vehicle to grid EV chargers – see section 5.14) can be made via Vector's website.

For generators that are designed to operate synchronised with Vector's network and have the ability to export energy, the customer must apply to Vector before connecting the generator: vector.co.nz/personal/electricity/distributed-generation

These generators include, but are not limited to, solar panels, wind generators or diesel generators.

In addition to the application for connection, the customer is also required to notify their Electricity Retailer to arrange the appropriate type of metering equipment. Certification of the installation (CoC, RoI etc) as proof that the generator is safe to operate is required prior to the commissioning of the generator.

Generators that cannot be connected to and synchronised with Vector's network (such as backup generators) are not required to go through the generator connection application process.

5.13 Battery storage systems

Vector must consent to the installation of any batteries capable of exporting power onto Vector's network (even if the customer does not intend to export) prior to installation. Applications for connection of such batteries can be made via Vector's website: vector.co.nz/personal/batteries/connecting-your-battery-to-our-network

5.14 Electric Vehicle chargers

Vector requires Electric Vehicle chargers connected to Vector's network to comply with the Publicly Available Specification (PAS) for electric vehicle (EV) chargers for residential use (SNZ PAS 6011:2021) and for commercial applications (SNZ PAS 6010:2021), published by Standards New Zealand (SNZ). These provide customers with quality guidance on the safe installation of smart home chargers and a Certificate of Compliance (CoC) must be issued.

As the CoC helps ensure Vector can more safely and effectively manage its electricity network, we ask for a copy as soon as possible following installation. Please provide a copy of the CoC (including ICP number) directly, or through your installer, to email EVinfo.applications@vector.co.nz

Bidirectional charging i.e. vehicle to grid (V2G) involves two-way electricity flows from Vector's network to the customer and from the customer to the network. To ensure public safety, and maintain the quality of supply, any such chargers must comply with AS/NZS 4777.2:2020 and Vector's distributed power generation requirements (Refer to Section 5.12).

5.15 Distributed Energy Resource Management

Smart load management via a Distributed Energy Resource Management System (DERMS) can help avoid costly network reinforcement, optimise the flexible operation of customer assets without compromising network security, and provide network resilience in the case of emergencies.

Customers' distributed energy resources (DERs) (e.g. EV chargers, batteries) can either be directly connected to Vector's DERMS platform, or indirectly via a third party's platform (e.g. Electricity Retailer or Distributed Energy Resource (DER) manager).

Customers connected to Vector's DERMS (directly or indirectly via a third party) may receive the benefit of a lower electricity tariff from their Electricity Retailer or third party DER manager.

Further information can be found on vector.co.nz/personal/electricity/about-our-network/pricing

6. Network connection configurations

This section describes the different types of configurations new customers can connect to the Vector network.

6.1 Configuration A – Underground residential and general connections

6.1.1 General ownership diagram

New supply connections in residential areas must be made via an underground pit or pillar. The following diagram shows a typical new residential supply connection.

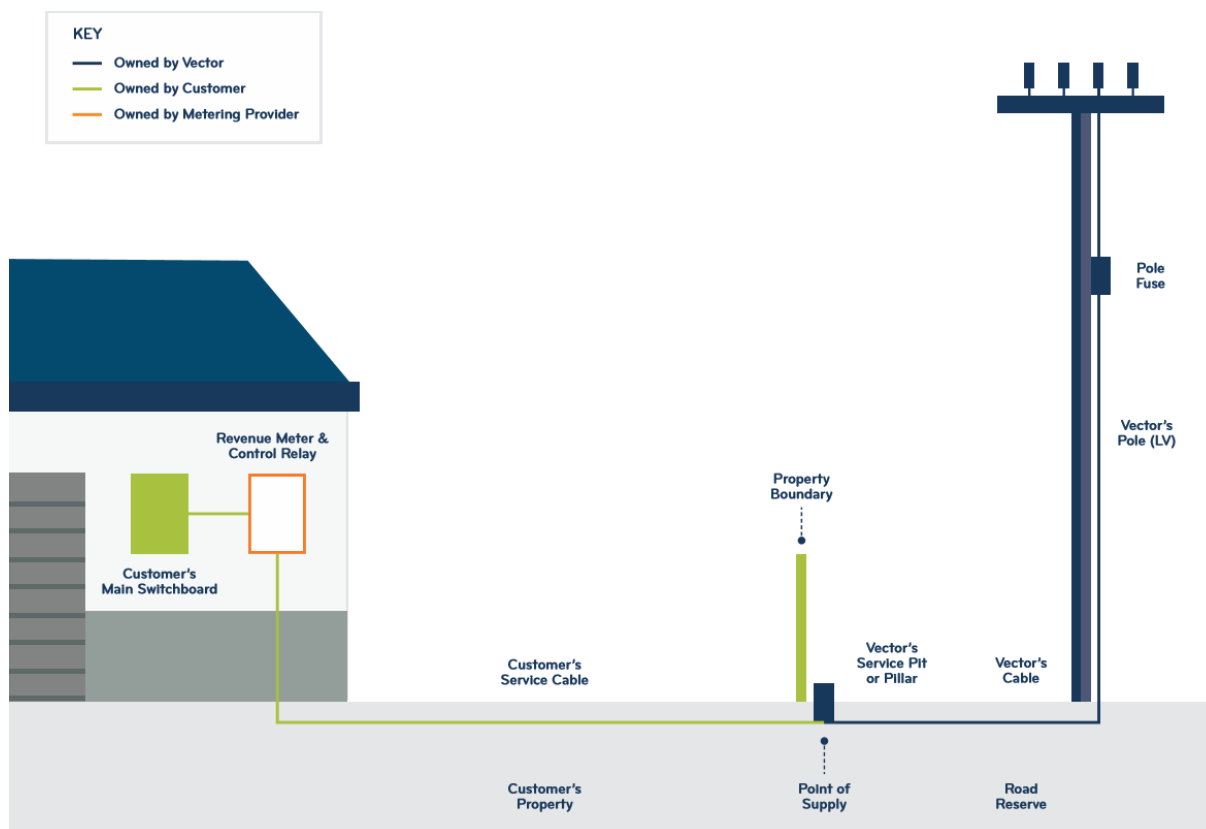

6.1.2 Customer responsibilities

- The customer is responsible for the construction and maintenance of their installation up to the Point of Supply (POS).
- Customers must be familiar with their obligations as detailed in section 3 of these Standards.

6.1.3 Important design requirements

- Electrical Service Providers must understand the technical requirements in Section 5 of these Standards and how this applies to the customer's installation.

6.2 Configuration B – Overhead residential and general connections for Rural areas

6.2.1 General ownership diagram

Overhead supplies for new connections are only allowed in rural areas. The following diagram shows a typical rural new supply connection.

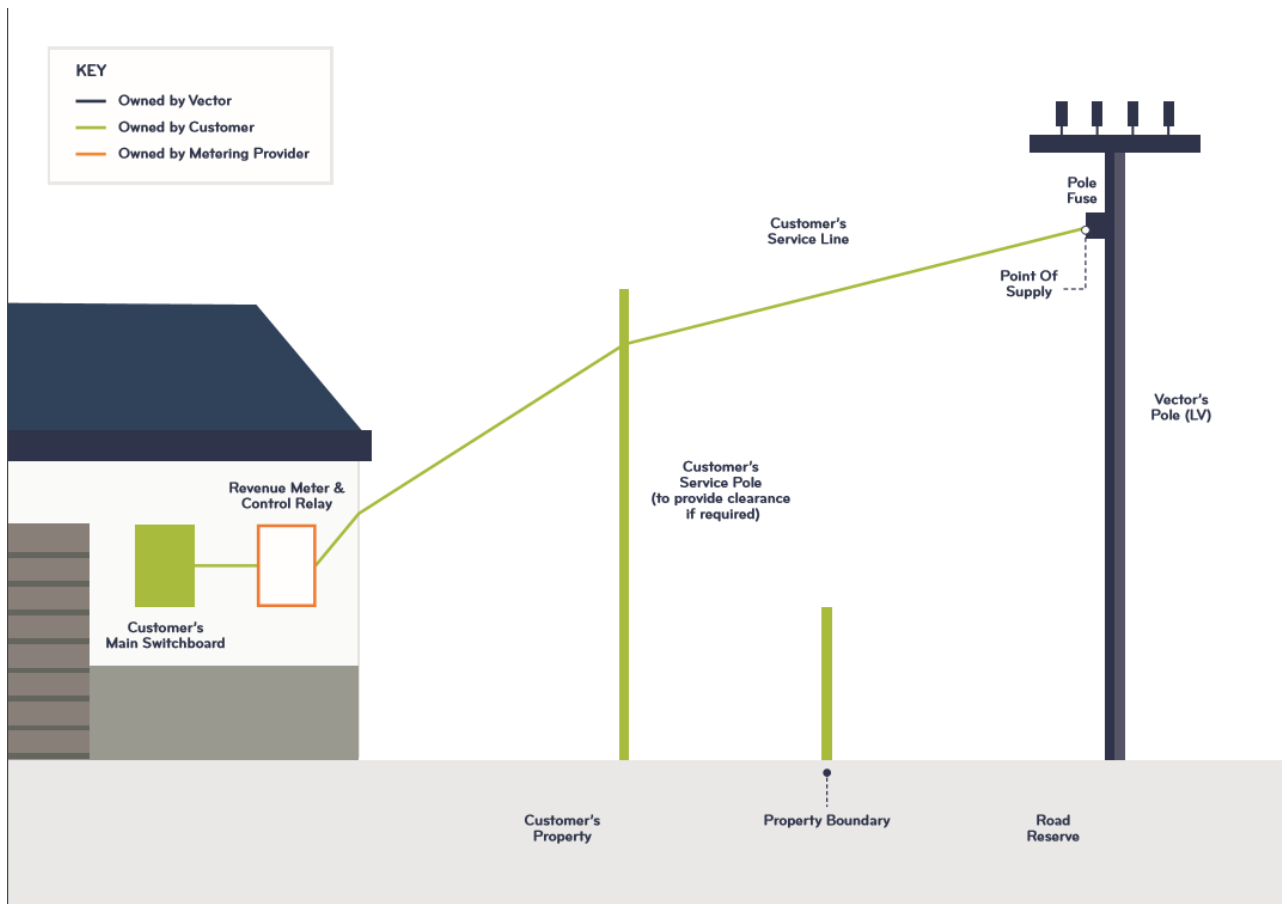

6.2.2 Customer responsibilities

- The customer is responsible for the construction and maintenance of their installation up to the Point of Supply (POS).
- Customers must be familiar with their obligations as detailed in section 3 of these Standards.
- It is strongly recommended to regularly inspect the condition of all external conductors and connections that the customer owns (the inspection must include any poles the customer may own). This is to ensure this equipment is in a good working condition and meets the clearance requirements of [ECP 34](#), particularly checking clearances of vegetation near the lines. The customer should discuss these requirements with their Electrical Service Provider as well as any other maintenance required on their installation.
- The customer should discuss with their Electrical Service Provider the required provisions for activities that require approaching overhead lines. Activities that risk encroaching the minimum approach distances stated in [ECP 34](#) may require Vector to de-energise the installation prior to the activities commencing.

6.2.3 Important design requirements

- Electrical Service Providers must understand the technical requirements in section 5 of these Standards and how this applies to the customer's installation.
- The Auckland Council Unitary Plan requires:
 - New connections to be made via underground cables in residential areas.
 - Rural connections may be either underground cables or overhead lines.
- Poles may be required to be installed on the customer's property to meet the safe electrical clearance requirements of [ECP 34](#). Any poles installed on the customer's property downstream of the Point of Supply are owned by the customer. The customer is responsible for the installation, repairs and maintenance of those poles.
- Electrical Service Providers must ensure that overhead conductors and poles are designed in accordance with AS/NZS 3000 section 3.12.
- Electrical Service Providers must ensure that the mechanical forces from the connections to Vector's overhead line do not compromise the stability of the pole and are designed in accordance with AS/NZS 3000 section 3.12.
- A transformer may be required to be installed on the customer's property to meet the requirements of AS/NZS 3000 section 3.6. For these requirements refer to configuration C.

6.3 Configuration C – Long overhead connections for rural areas

6.3.1 General ownership diagram

In some situations where electricity supply is required at a long distance from the property boundary, connection from Vector's LV network may not be practical due to excessive voltage drop. The practical solution is to connect the new supply via an HV line and a transformer, as shown in the diagram below.

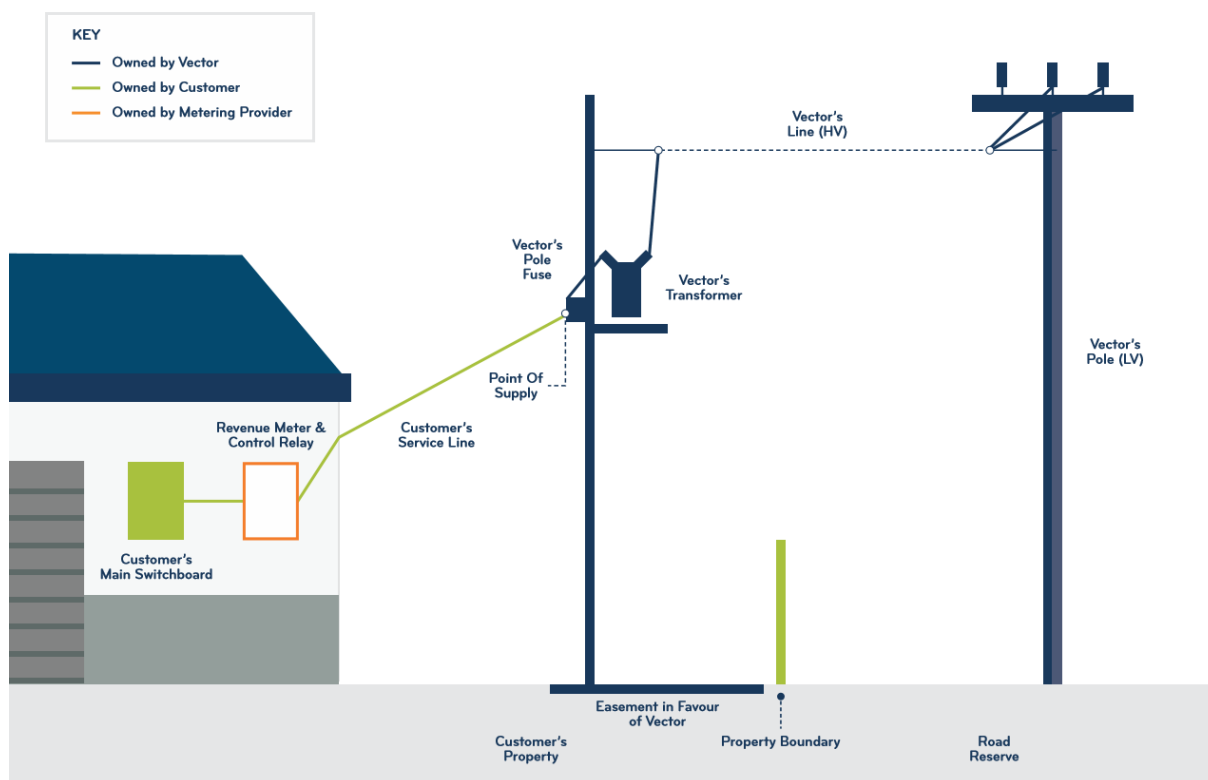

6.3.2 Customer responsibilities

- The customer is responsible for the construction, maintenance and repair of their installation up to the Point of Supply (POS).
- Customers must be familiar with their obligations as detailed in section 3 of these Standards.
- It is strongly recommended to regularly inspect the condition of all external conductors and connections that the customer owns (and poles if the customer owns any). This is to ensure this equipment is in a good working condition and meets the clearance requirements of [ECP 34](#), particularly checking clearances of vegetation near the lines. The customer should discuss these requirements with their Electrical Service Provider as well as any other maintenance required on their installation.
- The customer should discuss with their Electrical Service Provider the required provisions for activities that require approaching overhead lines. Activities that risk encroaching the minimum approach distances stated in [ECP 34](#) may require Vector to de-energise the installation prior to the activities commencing.

The customer must provide unrestricted maintenance access to Vector's equipment at all times as per the easement terms. For connections made before 1 January 1993, Vector's access rights are provided by section [23](#) of the Electricity Act 1992.

6.3.3 Important design requirements

- Electrical Service Providers must understand the technical requirements in section 5 of these Standards and how this applies to the customer's installation.
- Poles may be required to be installed on the customer's property to meet the safe electrical clearance requirements of ECP 34.
- The Electrical Service Provider must calculate the volt drop from the customer's installation to Vector's lines to determine if a transformer (as shown in the diagram above) is required to be installed to meet the requirements of AS/NZS 3000 section 3.6.
- Electrical Service Provider must ensure that overhead conductors and poles owned by the customer are designed in accordance with AS/NZS 3000 section 3.12.
- Depending on the rated capacity of the transformer, access issues and proximity of neighbours, this may be able to be shared across neighbouring properties. Vector, however, must approve this.

6.4 Configuration D – Multi-dwelling connections

6.4.1 General ownership diagram

Option 1: Vector owns the LV cables inside the customer's property (for example on right of ways):

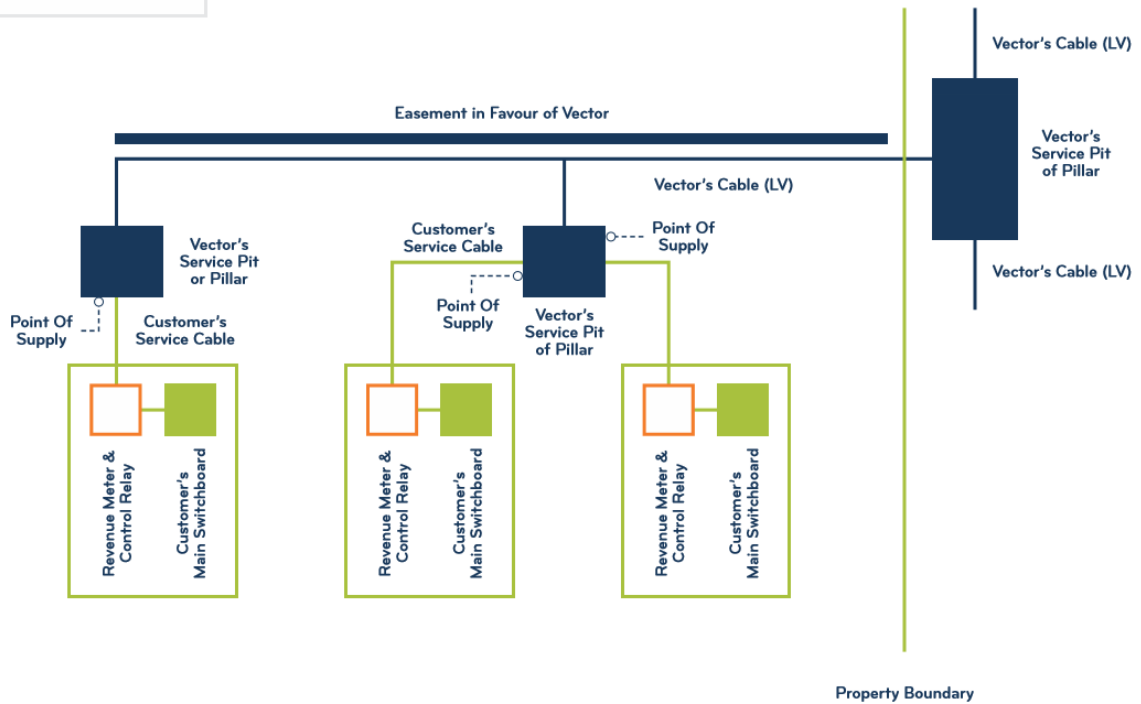
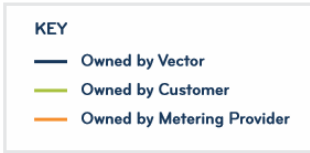

Note: Vector accepts reticulating inside right of ways provided that the customer agrees to grant an easement in favour of Vector (where required) to protect the equipment and allow Vector to operate and maintain the equipment. Vector will keep / maintain records of this equipment and the easement protecting it.

Option 2: The customers own the LV cables inside their property:

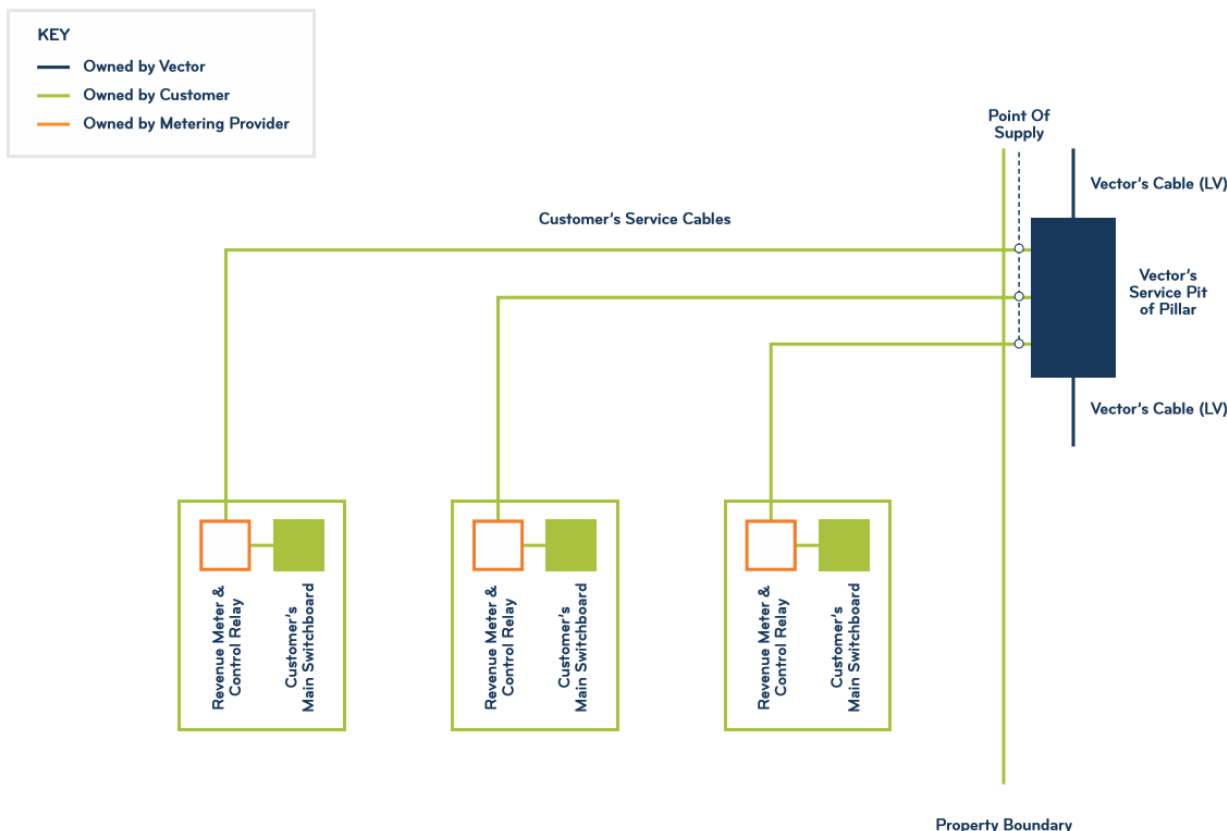

6.4.2 Customer responsibilities

The customer is responsible for the construction, maintenance and repair of their installation up to the Point of Supply (POS). Under Option 1, the Points of Supply for the three dwellings are at Vector's service pits or pillars where the customers' service cables are connected. Vector will install the LV cables and service pits or pillars within the easement area created in the customers' development and will require an easement to protect its cables and service pits or pillars inside the customers' property.

Under Option 2, the Points of Supply for the three houses are at Vector's service pits and pillars at the property boundary. The customers will install their service cables from their houses to Vector's service pit or pillar at the property boundary. No easement is needed.

Customers must be familiar with their obligations as detailed in section 3 of these Standards.

Vector is responsible for the ongoing repair and maintenance of equipment it owns. Customers are responsible for the ongoing repair and maintenance of equipment they own.

6.4.3 Important design requirements

- The Electrical Service Provider must understand the technical requirements in section 5 of these Standards and how this applies to the customer's installation.
- Multi-dwellings with more than five ICPs must have a single point of isolation (e.g. a switch or a fuse) for all the customers.
- The customer must provide unrestricted maintenance access to Vector's equipment at all times as per the easement terms.

6.5 Configuration E – Transformer connection (for connections over 100 A / 3 phase)

6.5.1 General ownership diagram

There are different ownership options:

Option 1: Vector installs its transformer and LV frame in a substation building provided by the customer. The substation may be a standalone structure or part of the customer's building.

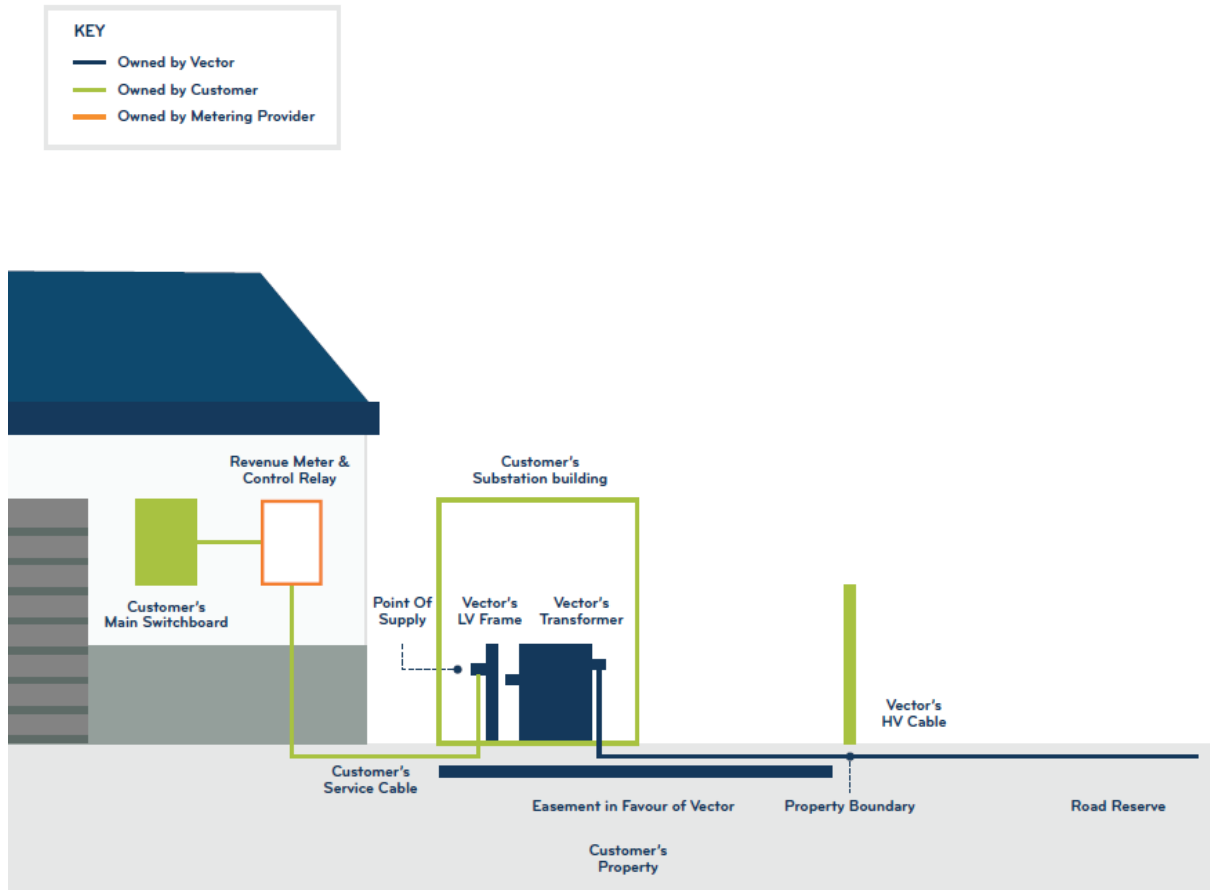

Option 2: Vector installs its own substation (transformer and LV frame in an outdoor enclosure) inside the customer's property.

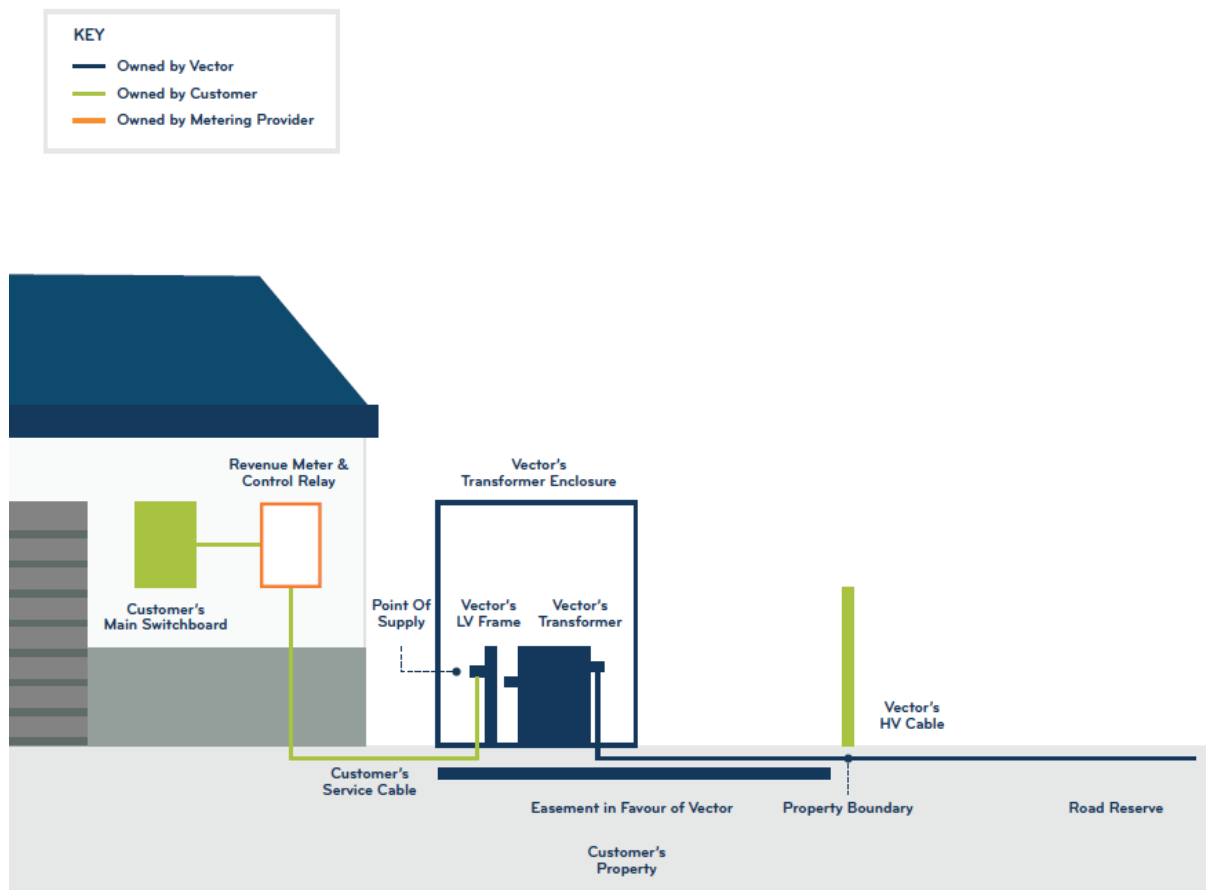

6.5.2 Customer responsibilities

- The customer is responsible for the construction, maintenance and repair of their installation up to the Point of Supply (POS).
- Customers must be familiar with their obligations as detailed in section 3 of these Standards.
- The customer must grant an easement in favour of Vector covering the area occupied by Vector's cables and substation.
- The customer must provide unrestricted maintenance access to Vector's equipment at all times as per the easement terms. For connections made before 1 January 1993, Vector's access rights are covered by section 23 of the Electricity Act 1992.
- As this configuration has complex customer responsibilities, the customer must discuss these with their Electrical Service Provider.

6.5.3 Design requirements

- The Electrical Service Provider must understand the technical requirements in section 5 of these Standards and how this applies to the customer's installation.
- Protection systems will be reviewed and agreed between Vector and the customer to ensure the settings are coordinated so that the customer's protection operates before Vector's network protection.
- The easement in this configuration is to allow Vector to access its equipment for maintenance or fault restoration.

- Vector will supply and design the transformer and substation in collaboration with the customer to ensure it meets their requirements.

6.6 Configuration F – HV Customer connections

6.6.1 General ownership diagram

Vector provides an HV source of supply for customers to connect their transformers. The HV source is usually at an HV switch. If the HV switch is installed inside the customer's property, an easement in favour of Vector is required to allow operation and maintenance of the equipment.

The following diagram shows that the metering is on the LV side. In some cases, when the customer's demand is very large, the Electricity Retailer or metering owner may require the metering to be carried out at HV. Any HV metering equipment will be arranged between the customer and the Electricity Retailer. Vector does not allow HV metering equipment to be installed in its switchboards.

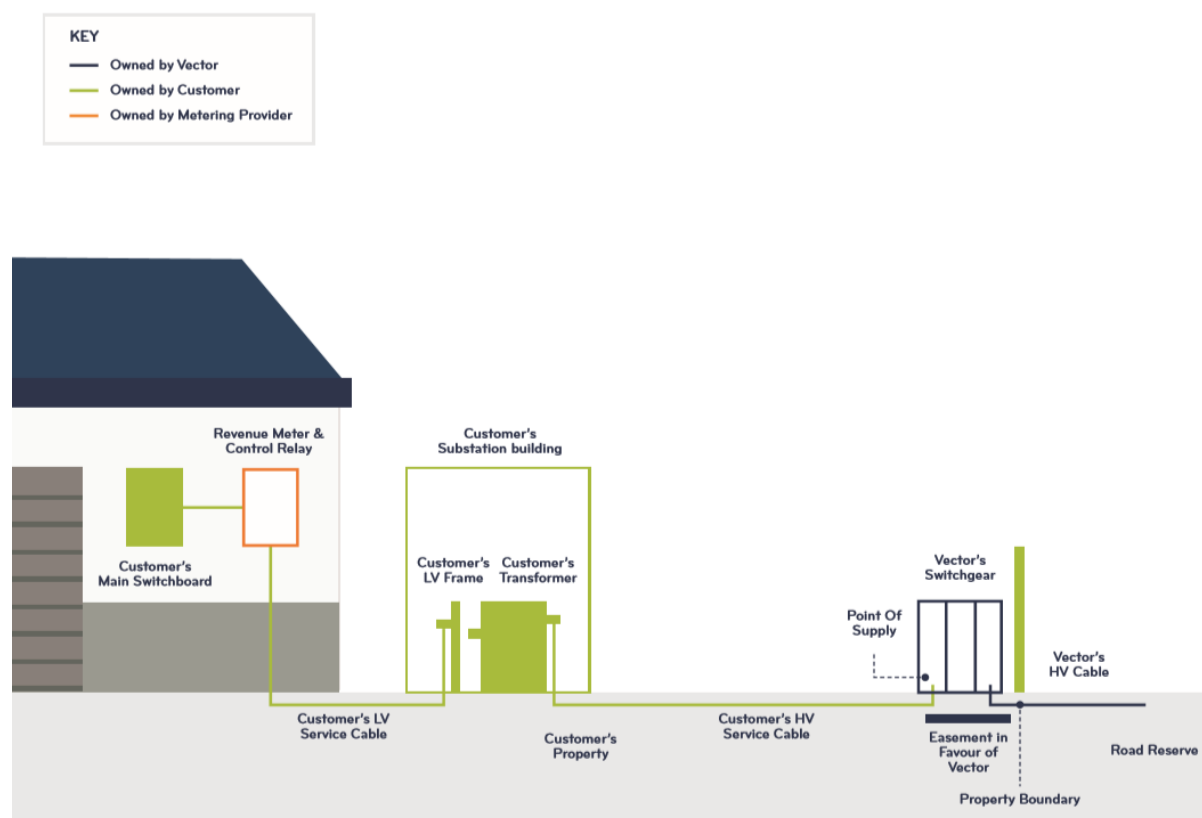

6.6.2 Important considerations before committing to this installation configuration

This installation configuration is usually only cost effective for installations 1MVA or over. In addition to this, the installation has many regulations for the customer to comply with to maintain and operate their HV equipment. It is highly recommended that the customer discusses these requirements with an HV Engineering Consultant to understand these requirements before committing to this type of connection.

In the above diagram, Vector's switchgear is installed inside the customer's property. An easement in Vector's favour covering the switchgear and associated cables will be required. The alternative is for Vector to install its switchgear outside the customer's premises, if it is practical to do so. Typically, customers who opt for this design own more than one transformer on site. In this case,

they may either request Vector to install multiple switch panels, or they will install their own switchgear for the connection of their transformers.

6.6.3 Customer responsibilities

- The customer must implement routine safety checking systems as per the Electricity Safety Regulations section [40](#).
- The customer must develop maintenance and operational procedures for their HV equipment based on best practises and to meet New Zealand legislation.
- The customer must employ competent Electrical Service Providers to maintain their equipment as detailed in section 2.3.1.
- The customer is responsible for the maintenance of their installation up to the Point of Supply.
- Customers must be familiar with their obligations as detailed in section 3 of these Standards.
- The customer must provide unrestricted maintenance access to Vector's equipment at all times as per the easement terms. For connections made before 1 January 1993, Vector's access rights are covered by section [23](#) of the Electricity Act 1992.
- As this configuration has complex customer responsibilities, it is highly recommended that the customer discusses these with an HV Engineering Consultant.

6.6.4 Important design requirements

- The Electrical Service Provider must understand the technical requirements in section 5 of these Standards and how this applies to the customer's installation.
- Protection systems shall be reviewed and agreed between Vector and the customer.
- Vector will design and install their switchgear in collaboration with the customer to ensure it meets all technical and health and safety requirements.
- The easement in this configuration is to allow Vector to access their equipment for maintenance or fault restoration. The design must adhere to all terms of the easement.

6.7 Configuration G – Transformer connections to commercial developments with multiple tenants

6.7.1 General ownership diagram

The following diagram shows a typical supply to a commercial development with multiple tenants. The development may be a high-rise office building (vertical development) or industrial park (horizontal development). Vector's supply from the LV terminals of the transformer is connected to the building's main switchboard from which the landlord and tenants are connected.

It should be noted that the developer may choose to own their transformer and become an HV connection. In this case, the developer needs to refer to the requirements of section 6.6 of these Standards.

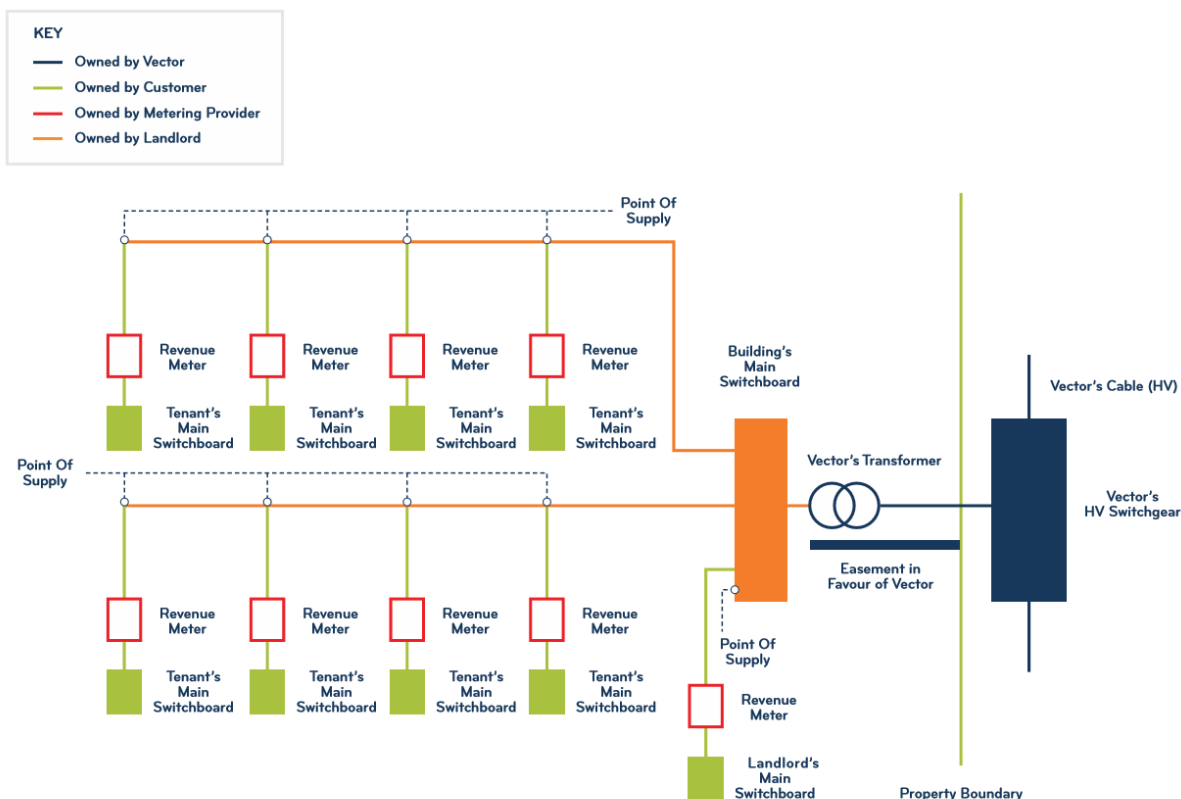

6.7.2 Customer responsibilities

- In this configuration, the developer of the site may (or may not) continue to own the building. For the purpose of this section, the roles of the developer and the customer are separated. The developer is responsible for constructing the installation within the building. Once completed, the building will be handed over to the landlord who will become responsible for the ongoing maintenance and operation of the building / installation. Vector will not be involved in the ongoing maintenance and operation of the wiring installation inside the development.
- The landlord will apply to Vector for a supply connection and be assigned an ICP number, thus becoming a customer of Vector.
- The landlord may choose to rent the building space to tenants and request Vector to assign ICP numbers to these tenants who would become Vector customers.
- The customer (landlord) must grant an easement in favour of Vector covering the area occupied by Vector's cables and transformer.
- The customer (landlord) must provide unrestricted maintenance access to Vector's equipment at all times as per the easement terms. For connections made before 1 January 1993, Vector's access rights are covered by section 23 of the Electricity Act 1992.

6.7.3 Important design requirements

- The Electrical Service Provider must understand the technical requirements in section 5 of these Standards and how this applies to the customer's installation.
- Protection systems shall be reviewed and agreed between Vector and the customer to ensure the gradings are coordinated.
- The easement in this configuration is to allow Vector to access its equipment for maintenance or fault restoration.

- Vector will supply and design the transformer and substation in collaboration with the customer to ensure it meets their requirements.

6.8 Customer sites supplied by multiple Points of Supply

Due to technical issues (such as load sharing between the different incoming circuits, increased prospective short circuit current, protection setting and back feeding from other Points of Supply) and potential safety hazards, customers are not allowed to interconnect the multiple Points of Supply supplying the site without prior written approval from Vector. In providing the approval, Vector will require site-specific information from the customer in order to make the assessment. Vector may impose terms on any approval granted.

The following scenarios are possible configurations for parallel operation of different Points of Supply:

1. *The site is supplied by more than one HV feeder from the same zone substation:* Except where two or more HV feeders are specifically designed to run in parallel (supplied from the same zone substation, installed along the same route in the same trench and with protection schemes designed to run the feeders in parallel), no parallel operation of the feeders is allowed.
2. *The site is supplied by more than one HV feeder from different zone substations which may be connected to different national grid exit points:* No parallel operation of the feeders is allowed.
3. *The site has multiple transformers owned by Vector to supply the customer's LV main switchboard:* Where Vector owns the transformers, it has an obligation to protect the equipment and operating personnel. Parallel operation of the transformers may result in certain faults (such as a fault at the HV tails connecting the transformer) not being detected. The only configuration for which parallel operation of transformers is allowed is for two transformers to form a group and for the group to be controlled by a single circuit breaker. Although this is allowed, it is not preferred.
4. *The site has multiple transformers owned by the customer to supply the customer's LV main switchboard:* The customer is responsible for the design and installation of the transformers, LV switchboard and protection schemes. Vector's responsibility is to ensure it provides the customer a means of protection and isolation. However, Vector does not recommend that the customer operate the transformers in parallel.







7. Disconnection from the Network

7.1 Disconnection of Customer Assets

Where a customer cable is permanently disconnected from the Vector network it is required to be removed completely from the Vector asset it was connected to. The removal must be undertaken in such a manner that the cable is removed outside of the Vector asset. This includes, but is not limited to, cables removed from transformer cubicles, switchgear termination kits, LV frames, fuses, pits, pillars, and TUDs, and complete removal of customer services off poles.

Appendix A DRAWINGS

These drawings show Vector's design standards and have been included here for the convenience of the reader. As these drawings are being reviewed when new information becomes available, please contact Vector for the latest version of these drawings:

Drawing Name	Drawing
EDE5001 Substation Room General	 EDE5001 Substation room General.pdf
EDE5002 Substation Room Equipment Layout	 EDE5002 Substation Room Equipment layc
EDE5007 Distribution Package Substation BFLR Rated Installation	 EDE5007 Distribution Package Substation Bi
EDE5008 Distribution Transformer Installation	 EDE5008 Distribution Transformer Installati
EDE5011 Service Pit Arrangement	 EDE5011 Service Pit Arrangement.pdf
EDE5012 Service Pillar Arrangement	 EDE5012 Service Pillar Arrangements.p

Appendix B FAULT LEVEL

B.1.1 11kV network

The following table shows the prospective short circuit currents at the LV terminals of the 11kV/LV distribution transformers supplied by Vector. These prospective short circuit currents are calculated using the following assumptions:

- Fault level at the 11kV terminals 13.1kA
- Transformer impedances based on supplier's data
- Earthing resistance (at substation and customer's premises) 1ohm

These figures may be used by customers for reference.

11kV / LV Transformer capacity	Three Phase Prospective Short Circuit Currents at the LV terminal (IEC Method)
100kVA	3.6kA
200kVA	6.3kA
300kVA	9.4kA
500kVA	14.6kA
750kVA	20.4kA
1000kVA	26.6kA

B.1.2 22kV network

The following table shows the prospective short circuit currents at the LV terminals of the 22kV/LV distribution transformers supplied by Vector. These prospective short circuit currents are calculated using the following assumptions:

- Fault level at the 22kV terminals 20.1kA
- Transformer impedances based on supplier's data
- Earthing resistance (at substation and customer's premises) 1ohm

These figures may be used by customers for reference.

22kV / LV Transformer capacity	Three Phase Prospective Short Circuit Currents at the LV terminal (IEC Method)
300kVA	8.6kA
500kVA	15.8kA
750kVA	21.3kA
1000kVA	22.0kA